

**D** Institutional, Medical and Lab Products



RELIABILITY BUILT IN™



# G-10 General Product Catalog

## Table of Contents



RELIABILITY BUILT IN<sup>SM</sup>

### Institutional, Medical and Lab Products – D

#### Single Lever Faucets ..... D4-5

- Single Lever Faucets, Deck and Side Mount, Centerset, Swivel and Rigid Gooseneck Assemblies

#### ChekPoint™ Electronic Faucets ..... D6-12

- ChekPoint™ Electronic Sensor Faucets, Deck, Wall and Side Mount, Rigid Gooseneck and Cast Spout Assemblies

**NEW MODELS!** Electronic Faucets D8-10

#### Medical and Lavatory Faucets ..... D13-27

- Medical Lavatory Faucets with or without Adjustable Centers D13-15, 19-20
- Centerset Faucets with or without Pop-Up Assembly D16-18, 21
- Pivot Action Metering Valve Faucets D22-23
- Slow Self-Closing Metering Faucets D23-25
- NEW!** Wrist Action Metering Faucets D26
- Surgical Sink Faucets D27

#### Pedal Valves, Dummy Goosenecks and Bubblers ..... D28-31

- Single and Double Pedal Valves D28-29
- Knee Valves D29
- Dummy Goosenecks D30-31
- Bubblers D31

#### Service Sink and Sill Faucets ..... D33-40

- Service Sink Faucets with Vacuum Breakers D33-38
- Service Sink Faucets with Built-In Stops D33-38
- Service Sink Faucet Accessories D39
- Sill and Heavy Duty Sink Faucets D39-40

#### Medical Bedpan Washers ..... D41-43

#### Bath and Shower ..... D44-49

- Bath and Shower Combinations D48
- Concealed Bypass Mixing Valves D44
- Concealed Single Valves D44
- Accessories and "Shower Queen" Personal Spray Assemblies D45, 48-49

**NEW!** Pressure Balancing Shower Valves D3, 46-47

#### Vacuum Breaker Assemblies ..... D50

#### Laboratory Products ..... D51-64

- Lab Hose Cocks and Turrets D51-53
- Panel Flanges D53
- Stops D53
- Remote Control Valve Units D54
- Fume Hood Fittings D54
- Fittings, Support Rods and Accessories D55-56
- Lab Faucets, Double and Single Ledge, Combination Faucets, Single Temperature Faucets and Lab Accessories D56-64

#### Stops and Supplies ..... D64-85

- Straight and Angle Loose Key Stops

#### Parts Kits ..... D65-67

#### Faucet Fittings ..... D68-78

- Nozzles, Goosenecks, Spouts, Aerators, Outlets, Handles, Conversion Adapters, Quick-Connections, Supplies, Risers and Connectors, Inlets, Inlet Extensions, Outlets and Wall Hooks

**NEW!** Low Flow Aerators/Outlets D72-73

#### Water Conservation Models ..... D79-84

- The T&S Commitment to Water Conservation
- T&S Water-Saving Plumbing Models
- Low Flow Aerators and Outlets
- Water Conservation Products – Definitions and Use

#### NOTE:

A comprehensive Index By Model or Part Number and Page can be found in the G-10 General Product Catalog "Master Index" section (IN).



**RELIABILITY BUILT IN™**



## T&S Brass is Pleased To Introduce Our Extended Line of High-Quality Shower Valve Products



**B-3200**

When you choose a **T&S Brass** product, you know you've chosen one with **Reliability Built In™**.

We are pleased to present our new **Pressure Balancing Shower Valve** product line which includes various combinations of products to meet your specific needs:

- A solid brass **Pressure Balancing Shower Valve**, along with a selection of trims and other components
- 2.5 GPM **Shower Head**
- Solid brass **Tub Spout**
- Removable **Hand-held Spray** with flow control adjustment (from 0.5 GPM to 2.0 GPM)

Our **Pressure Balancing Shower Valve** features a solid brass

construction with replaceable ceramic cartridge, integral supply stops, 1/2" sweat connections and adjustable temperature limit stop. In addition to these features, it is ASSE 1016 Listed and ADA Compliant. It can be ordered alone for rough-in applications. The trim kit and other components can also be ordered separately to suit your installation requirements.

Related Shower Valve products include:

- Solid brass **Tub Spout with Diverter Lift Knob** in a polished chrome finish
- **Ceramic Cartridge** with rotary actuation and adjustable temperature limit stop
- Polished chrome 2.5 GPM **Shower Head**
- Polished chrome **Rotary Handle**
- Polished chrome **Faceplate** with screws and gasket



**Pressure Balancing Shower Valve B-3204-PBV**

Check out our **NEW B-3300 Series Pressure Balancing Shower Valve Assemblies**, now with threaded connections!

See pages D46-47 for more information about these new models



### Models available:

<b>B-3200</b>	Pressure balancing shower valve, 2.5 GPM shower head and tub spout
<b>B-3201</b>	Pressure balancing shower valve and 2.5 GPM shower head
<b>B-3204</b>	Pressure balancing shower valve with trim plate and handle
<b>B-3204-PBV</b>	Pressure balancing shower valve only
<b>B-3205</b>	Pressure balancing shower valve and hand-held spray assembly
<b>B-3206</b>	Includes B-3201 shower valve/shower head, B-1097 diverter valve and B-0925 Shower Queen spray assembly with grab bar
<b>B-3206-VB</b>	Includes B-3206 and a B-0970-VB attached to Shower Queen hose

**NEW!**

### Spare Parts and Accessories:

<b>017439-45</b>	Solid brass tub spout with diverter lift knob, polished chrome finish
<b>017441-45</b>	Ceramic cartridge, rotary actuation with adjustable temperature limit stop
<b>017442-45</b>	Polished chrome shower head with ball joint, arm and wall flange assembly
<b>017443-45</b>	Polished chrome rotary handle
<b>017444-45</b>	Polished chrome face plate with screws and gasket

**T&S Brass and Bronze Works, Inc.**  
[www.tsbrass.com](http://www.tsbrass.com)

2 Saddleback Cove • P.O. Box 1088  
Travelers Rest, SC 29690  
Phone 864.834.6715 • Fax 864.834.3518

## Single Lever Faucets

**NEW MODELS!**



All models have: • Temperature limit stops • Ceramic Cartridge with 2-year warranty

### B-2711 Single Lever Faucet

- Forged brass body
- 4" (152 mm) centerset faucet
- 4" (152 mm) handle
- 1/2" NPSM male inlet shanks
- 2.2 GPM aerator



- B-2710** Same as B-2711 except with pop-up drain assembly
- B-2710-LH** Same as B-2710 except with 6" (152 mm) long handle
- B-2711-LH** Same as B-2711 except with 6" (152 mm) long handle
- B-2710-WS** Same as B-2710 except with low-flow aerator (1.5 GPM)
- B-2711-WS** Same as B-2711 except with low-flow aerator (1.5 GPM)
- B-2710-F05** Same as B-2710 except with non-aerated spray device (0.5 GPM)
- B-2710-VF05** Same as B-2710 except with vandal-resistant non-aerated spray device (0.5 GPM)
- B-2711-F05** Same as B-2711 except with non-aerated spray device (0.5 GPM)
- B-2711-VF05** Same as B-2711 except with vandal-resistant non-aerated spray device (0.5 GPM)

### B-2730 Single Lever Mixing Faucet

- Forged brass body
- 4' (.9 m) sidespray and hose
- 9" swivel spout
- 16" long flexible supply hoses with 3/8" compression fittings
- Chrome plated deckplate



- B-2730-07** Same as B-2730 except with 7' hose on sidespray
- B-2730-3H** Same as B-2730 except with 4' hose on sidespray
- B-2730-LH** Same as B-2730 except with 6" (152 mm) long handle
- B-2730-WS** Same as B-2730 except with low-flow aerator (1.5 GPM)
- B-2731** Same as B-2730 except less sidespray
- B-2731-LF15** Same as B-2731 except with vandal-resistant laminar flow device (1.5 GPM)
- B-2731-LH** Same as B-2711 except with 6" (152 mm) long handle
- B-2731-VF05** Same as B-2731 except with vandal-resistant spray device (0.5 GPM)
- B-2731-WS** Same as B-2730 except with low-flow aerator (1.5 GPM)

### B-2741 Single Lever Faucet

- Single lever side mount base faucet
- Rigid gooseneck assembly with B-0199-07 aerator
- Two (2) 17" long flexible supply hoses with 3/8" compression fittings



### B-2742 Single Lever Faucet

- Single lever side mount base faucet
- Swivel gooseneck assembly with B-0199-06 aerator
- Two (2) 17" long flexible supply hoses with 3/8" compression fittings



- B-2742-A22** Same as B-2742 except with aerator (2.2 GPM)
- B-2742-LF05** Same as B-2742 except with aerator (0.5 GPM)
- B-2742-LH** Same as B-2742 except with long handle

### B-2743 Single Lever Faucet

- Single lever side mount base faucet
- Swivel gooseneck assembly with B-0199-06 aerator
- Two (2) 17" long flexible supply hoses with 3/8" compression fittings
- Integral diverter for water flow through sidespray or gooseneck



### B-2744 Single Lever Faucet

- Single lever side mount base faucet
- Rigid gooseneck assembly with B-0199-06 aerator
- Two (2) 17" long flexible supply hoses with 3/8" compression fittings
- Integral diverter for water flow through sidespray or gooseneck



## Single Lever Faucets

**NEW MODELS!**

- All models have:
- Temperature limit stops
  - Ceramic Cartridge with 2-year warranty



### B-2701 Single Lever Faucet

- Single lever faucet with rigid base
- Ceramic cartridge with temperature limit adjustment
- 2.2 GPM aerator
- 3/8" compression female flexible stainless steel supplies



**B-2701-AR** Same as B-2701 except with vandal-resistant aerator

**B-2701-VF05** Same as B-2701 except with vandal-resistant non-aerated spray device (0.5 GPM)

**B-2701-VR** Same as B-2701 except vandal-resistant aerator (2.2 GPM)

### B-2703 Single Lever Faucet

- Single lever faucet with rigid base
- 6" deck plate (4" c/c)
- Ceramic cartridge with temperature limit adjustment
- 2.2 GPM aerator
- 3/8" compression female flexible stainless steel supplies



**B-2703-LF15** Same as B-2703 except with laminar flow device (1.5 GPM)

**B-2703-VF05** Same as B-2703 except with vandal-resistant non-aerated spray device (0.5 GPM)

### B-2745 Side Mount Faucet

- Side mount mixing faucet with B-2740 side mount base
- B-1000 48" flexible stainless steel hose and spray assembly

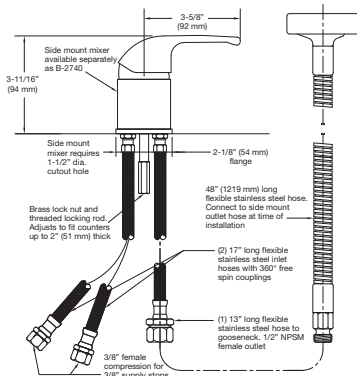

### B-2746 Side Mount Faucet

- Side mount faucet with single lever base mixing faucet
- 3/8" compression female flex stainless steel supplies
- B-2403 swing nozzle with aerator (2.2 GPM)

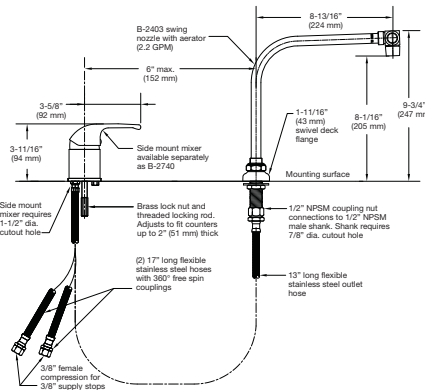

### B-2740 Side Mount Faucet

- Side mount faucet with remote on/off control base
- Flexible stainless steel water connectors

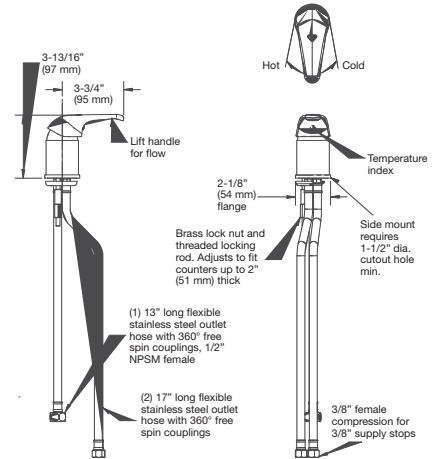

### B-2749 Side Mount Faucet with Remote Control Base

- Side mount mixing faucet with remote control base
- 3/8" compression female flex stainless steel supplies
- Swivel gooseneck with vandal-resistant aerator (2.2 GPM)
- Under the counter vacuum breaker (B-0970-FE) on hose
- Countertop mounted spray valve (B-0101) with 38" stainless steel hose (under the counter)

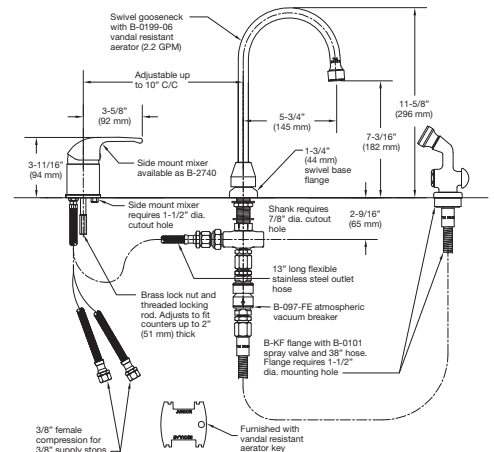

Introducing...



## Our Extended Line of ChekPoint™ Electronic Faucets

There are many more options to choose from with our water-saving T&S ChekPoint™ Electronic Sensor Faucets!

Along with ease of installation and a convenient AC/DC control module, **new options** are available to customize ChekPoint faucets:

**NEW!**

- -HG Hydro-generator option (all models)
- -LF22 2.2 GPM vandal-resistant laminar flow option (all models)
- -LF05 0.5 GPM vandal-resistant laminar flow option (all models)
- -LN Less nozzle option (EC-3100, EC-3101 faucet bodies)
- -SB Surgical Bend Gooseneck option (EC-3100, EC-3101)
- -SM Side-mount option (EC-3100, EC-3102)
- -SMT Side mount with thermostatic valve option (EC-3100, EC-3102)
- -TMV Below deck thermostatic mixing valve option (all models)

Our EC-3100 deck-mounted or EC-3101 back splash-mounted models allow you to specify any T&S rigid gooseneck you require.

Our EC-HARDWIRE and EC-EASYWIRE allow you to gang up to eight ChekPoint faucets while using only one power supply.

Our EC-3106 Electronic Faucet has a unique dual mode feature allowing for either electronic or manual operation.

## ChekPoint Faucets – Reliable By Design

### Standard Features

- Hands-free washing greatly reduces risk of contamination
- Sensor-operated faucets conserve water
- Water-resistant circuit control module
- Each model comes with the convenience of electric plug-in (AC) and battery (DC) power options
- ADA-compliant 
- Adjustable temperature control mixing valve
- Proven electronic technology
- Adjustable automatic time-out feature
- Adjustable water shut-off delay
- Chrome plated brass
- Troubleshooting LED indicator lights
- Scratch-resistant sensor lens
- Filtered solenoid valve with serviceable strainer filter
- Modular quick-release sensor connections
- Low battery indicator light
- Pre-assembled with appropriate mounting hardware included
- Vandal-resistant aerators (2.2 GPM)
- Check valves for cross-flow prevention in all models
- Requires no sealants for easy installation

**EC-3100**  
Deck-mounted gooseneck

**EC-3101**  
Back splash-mounted gooseneck

**EC-3102**  
Deck-mounted cast spout

**EC-3103**  
Deck-mounted cast spout

**NEW!**  
**EC-3106**  
Deck-mounted cast spout

**NEW!**  
**EC-3122 (right)**  
Deck-mounted cast spout

**NEW!**  
**EC-3100-LF22-SB**  
Deck-mounted surgical bend gooseneck

## Chekpoint™ Electronic Sensor Faucets

**NEW MODELS!**



All models have: • 2.2 GPM vandal resistant aerator

• AC/DC control module (electric plug-in and battery)

### EC-3100 Electronic Faucet



- Deck-mounted gooseneck
- Height: 11-1/4" (286 mm)
- Spread: 4-1/8" (105 mm)
- Clearance: 7-5/16" (185 mm)

**EC-3100-120X** Same as EC-3100 except with 5-1/2" spread gooseneck

**EC-3100-LF22** Same as EC-3100 except with 2.2 GPM laminar flow vandal resistant aerator

**EC-3100-LN** Same as EC-3100 except without gooseneck and aerator

**EC-3100-VF05** EC-3100 faucet with 0.5 GPM vandal-resistant spray device



### EC-3101 Electronic Faucet

- Wall-mounted cast spout
- Height: 11" (280 mm)
- Spread: 4-1/8" (104 mm)
- Clearance: 5-9/16" (141mm)

**EC-3101-LF22** Same as EC-3101 except with 2.2 GPM laminar flow vandal resistant aerator

**EC-3101-LN** Same as EC-3101 except without gooseneck and aerator

**EC-3101-VF05** EC-3101 faucet with 0.5 GPM vandal-resistant spray device

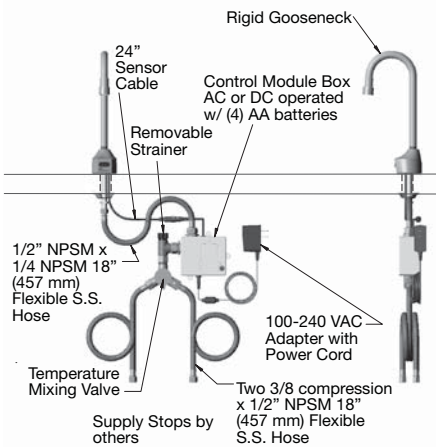

To order the standard CheckPoint™ Sensor Faucet models to include the hydro-generator (add -HG):

- EC-3100-HG** **EC-3101-HG**
- EC-3102-HG** **EC-3103-HG**
- EC-3106-HG**

To order the standard CheckPoint™ Sensor Faucet models to include the thermostatic mixing valve (add -TMV):

- EC-3100-TMV**
- EC-3101-TMV**
- EC-3102-TMV**
- EC-3103-TMV**
- EC-3106-TMV**

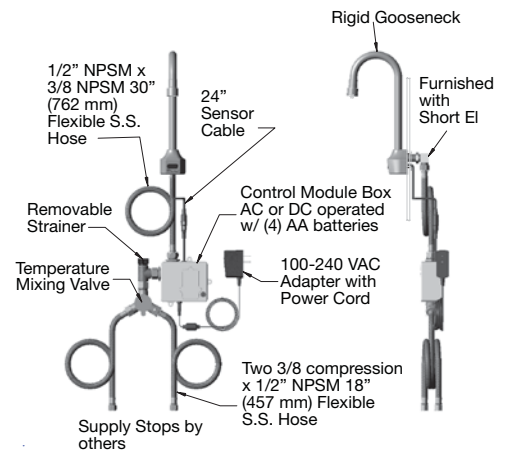

### EC-3102 Electronic Faucet

- Deck-mounted cast spout
- Height: 5-1/16" (129 mm)
- Spout length: 4-7/8" (124 mm)
- Clearance: 4-1/16" (103 mm)

**EC-3102-LF22** Same as EC-3102 except with 2.2 GPM laminar flow vandal-resistant aerator

**EC-3102-VF05** EC-3102 faucet with 0.5 GPM vandal-resistant spray device

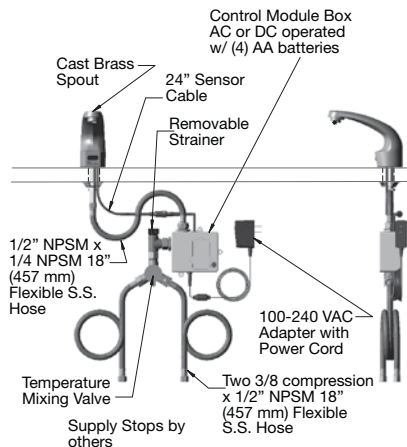

**EC-3103  
and  
EC-3106  
Electronic  
Faucets  
(on next page)**



## ChekPoint™ Electronic Sensor Faucets



All models have: • 2.2 GPM vandal resistant aerator • AC/DC control module (electric plug-in and battery)

### EC-3103 Electronic Faucet

- Deck-mounted cast spout
- Height: 5-1/16" (129 mm)
- Spout length: 4-7/8" (124 mm)
- Clearance: 4-1/16" (103 mm)

**EC-3103-LF22** Same as EC-3103 except with 2.2 GPM laminar flow vandal resistant aerator

**EC-3103-VF05** EC-3103 faucet with 0.5 GPM vandal-resistant spray device

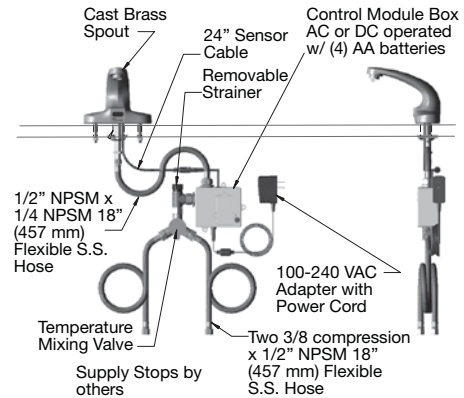

### EC-3106 Electronic Faucet with Manual Override

- Chrome plated brass single hole deck-mounted electronic sensor faucet
- Cast spout with 2.2 GPM (8.3 LPM) vandal-resistant aerator and manual bypass operation
- Modular assembly for easy installation (Note: supply stops to be supplied by others)
- AC/DC waterproof control module box with serviceable strainer filter
- (2) 3/8" compression, 18" (457 mm) long flexible stainless steel hot and cold water supply hoses
- Check valve assembly for crossflow prevention
- Hands-free washing reduces risk of contamination and saves water

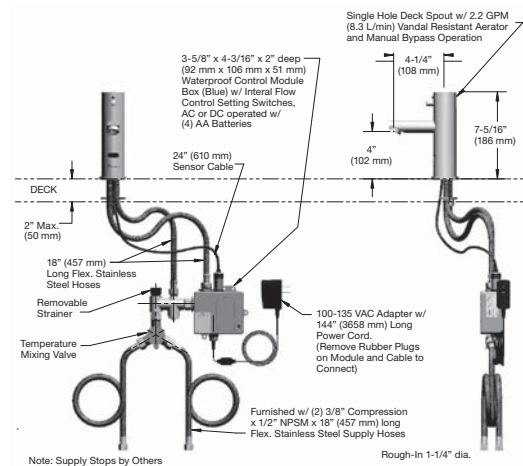

**EC-3106-VF05** EC-3106 faucet with 0.5 GPM vandal-resistant spray device

### EC-3100-LF22-SB Electronic Faucet

- Chrome plated brass single hole deck-mounted electronic sensor faucet
- Surgical bend rigid gooseneck with 2.2 GPM (8.3 LPM) laminar flow vandal-resistant aerator
- Modular assembly for easy installation (Note: supply stops to be supplied by others)
- AC/DC waterproof control module box with serviceable strainer filter
- (2) 3/8" compression, 18" (457 mm) long flexible stainless steel hot and cold water supply hoses
- Check valve assembly for crossflow prevention
- Hands-free washing reduces risk of contamination and saves water



### NEW MODEL!

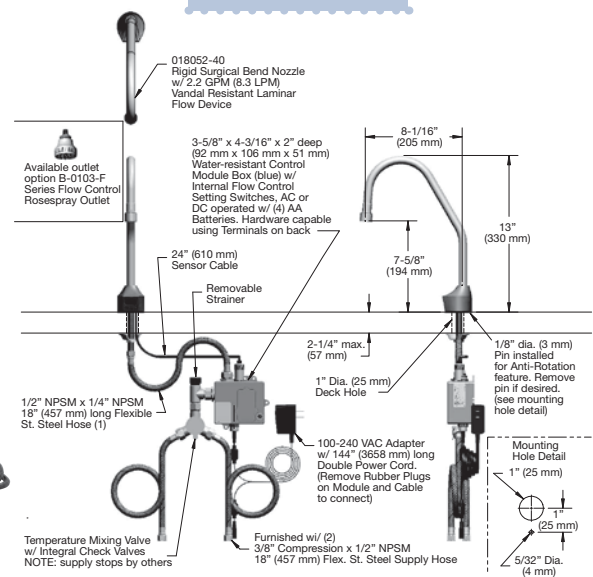

**EC-3101-LF22-SB** Same as EC-3100-LF22-SB except with EC-3101 faucet body



## ChekPoint™ Electronic Sensor Faucets with Above Deck Electronics and Temperature Control

NEW MODELS!



### EC-3122 Electronic Faucet

- Chrome plated brass single hole deck-mounted electronic sensor faucet
- Above deck electronics for easy installation and maintenance
- Chrome plated brass body (AB1953 compliant)
- Temperature mixing handle
- Modular assembly for easy installation (Note: supply stops to be supplied by others)
- (2) 3/8" compression, 19" (483 mm) long flexible stainless steel hot and cold water supply hoses
- 2.2 GPM vandal-resistant aerator
- Check valve assembly for crossflow prevention
- AC/DC power option
- Hands-free washing reduces risk of contamination and saves water



A recommended 2012 Money-Saving Product in BUILDINGS magazine

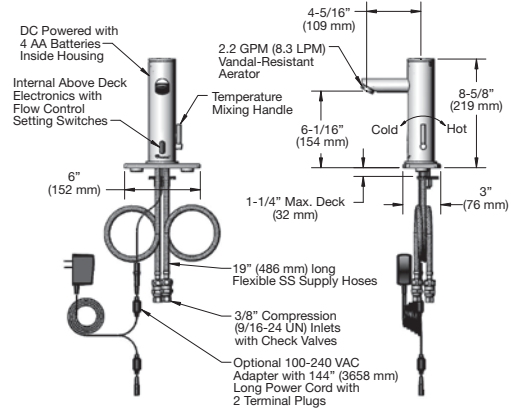

### EC-3122-4DP and EC-3122-8DP Electronic Faucets

#### EC-3122-4DP:

- EC-3122 ChekPoint Electronic Sensor Faucet with 4" (152 mm) forged brass deck plate with 1-1/2" center hole

#### EC-3122-8DP (shown below):

- EC-3122 ChekPoint Electronic Sensor Faucet with 8" (305 mm) forged brass deck plate with 1-1/2" center hole

### EC-3122-HG Electronic Faucet

- EC-3122 ChekPoint Electronic Sensor Faucet with EC-HYDROGEN hydro-generator

### EC-3122-VF05 Electronic Faucet

- EC-3122 ChekPoint Electronic Sensor Faucet with 0.5 GPM vandal-resistant aerator

## EC-3122 ChekPoint™ Electronic Sensor Faucet Accessories and Parts

### EC-3122 ChekPoint Sensor Faucet Options

EC-3122	ChekPoint Electronic Faucet, Single Hole Deck Mount, Above Deck Electronics and Temp Control
EC-3122-4DP	ChekPoint Electronic Faucet, Single Hole Deck Mount, 4" Deck Plate, Above Deck Electronics, Temp Control
EC-3122-8DP	ChekPoint Electronic Faucet, Single Hole Deck Mount, 8" Deck Plate, Above Deck Electronics, Temp Control
EC-3122-HG	ChekPoint Electronic Faucet, Single Hole Deck Mount, Above Deck Temp Control, EC-Hydrogen
EC-3122-VF05	ChekPoint Electronic Faucet, Single Hole Deck Mount, Above Deck Temp Control, 0.5 GPM Vandal-resistant Aerator

### ChekPoint Sensor Faucet Accessories and Replacement Parts

018227-45	Battery Holder for EC-3122 ChekPoint Electronic Sensor Faucet
018230-45	Temperature Control Handle with Screw, EC-3122
018232-45	Check Valve Adapter Assembly, EC-3122
018233-45	Mounting Hardware Kit, EC-3122
018160-40	Cap for EC-3122 ChekPoint Electronic Sensor Faucet

NEW MODELS!

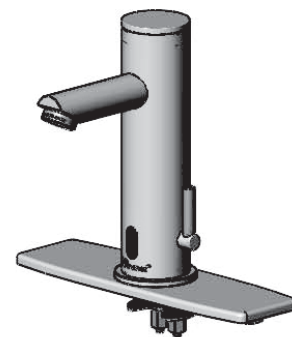

EC-3122-8DP

## ChekPoint™ Electronic Faucets with Side Mount Faucet

All models have: • 2.2 GPM vandal resistant aerator • AC/DC control module (electric plug-in and battery)

### EC-3100-SM Side Mount Faucet



**NEW MODELS!**

- EC-3100 chrome plated brass deck mounted gooseneck electronic sensor faucet, mounted 4" C/C with B-2740 single lever side mount control faucet
- B-2740 side mount faucet regulates water temperature and "on/off" setting (Note: Side mount control should remain in "OPEN" position for proper operation of sensor faucet)
- Rigid gooseneck with 2.2 GPM vandal-resistant aerator
- Modular assembly for easy installation (Note: supply stops to be supplied by others)
- 10" forged deck plate
- AC/DC waterproof control module box with serviceable strainer filter
- (2) 3/8" compression, 17" (432 mm) long flexible stainless steel hot and cold water supply hoses
- Check valve assembly for crossflow prevention
- Hands-free washing reduces risk of contamination and saves water

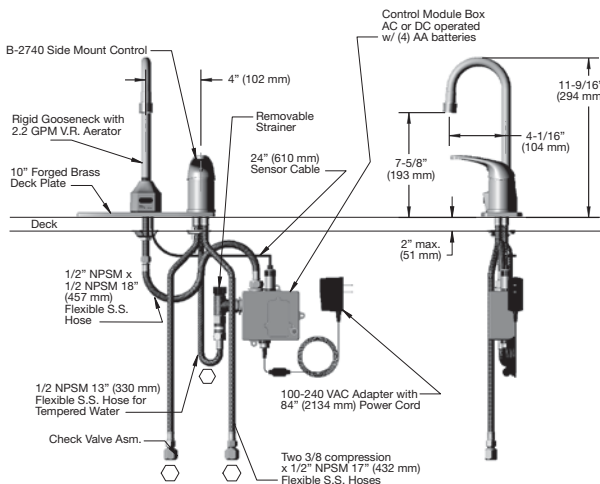

**EC-3100-5M-4DP** Same as the EC-3100 except with a 6" (152 mm) forged brass deck plate

### EC-3102-SM Side Mount Faucet

- EC-3102 chrome plated brass deck mounted cast spout electronic sensor faucet, mounted 4" C/C with B-2740 single lever side mount control faucet
- B-2740 side mount faucet regulates water temperature and "on/off" setting (Note: Side mount control should remain in "OPEN" position for proper operation of sensor faucet)
- Cast spout with 2.2 GPM vandal-resistant aerator
- Modular assembly for easy installation (Note: supply stops to be supplied by others)
- 10" forged deck plate
- AC/DC waterproof control module box with serviceable strainer filter
- (2) 3/8" compression, 17" (432 mm) long flexible stainless steel hot and cold water supply hoses
- Check valve assembly for crossflow prevention
- Hands-free washing reduces risk of contamination and saves water

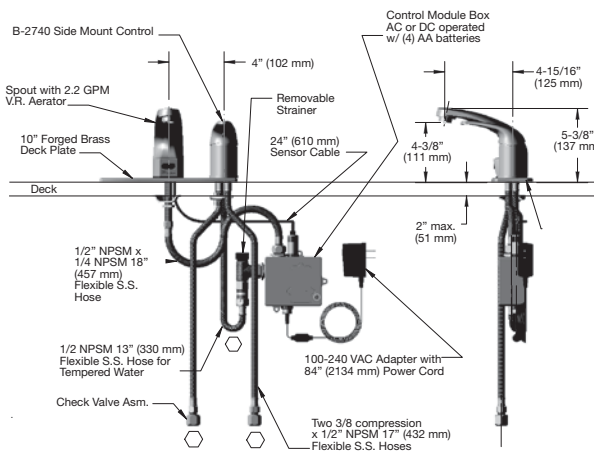

D  
10

## ChekPoint™ Electronic Faucets and Deck Plates

### Electronic Faucet Deck Plate Part Numbers

- To add a deck plate to an existing ChekPoint Electronic Faucet, order with these part numbers for each EC- faucet model

EC-models	4" Deck Plate	8" Deck Plate
EC-3100	013433-40	013434-40
EC-3101	013433-40	013434-40
EC-3102	013433-40	013434-40
EC-3103	n/a	n/a
EC-3106	013433-40	013434-40
EC-3122	018282-40	018507-40



## EC-HYDROGEN Hydro-Generator Accessory For ChekPoint™ Faucets

- Hydro-generator with 1/2 NPSM male inlet and outlet threads
- Accessory for all ChekPoint™ electronic sensor faucets
- Includes generator, (1) 1/2 NPSM swivel coupling
- 71" (1800 mm) power cord with male plug to connect to control module
- Average estimated lifespan for EC-HYDROGEN is ten years (estimate based on 1 million cycles in lab testing; individual results may differ)

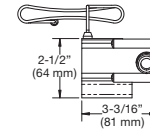

To order the standard ChekPoint™ Sensor Faucet models to include the hydro-generator (add -HG):

**EC-3100-HG    EC-3101-HG**  
**EC-3102-HG    EC-3103-HG**  
**EC-3106-HG**

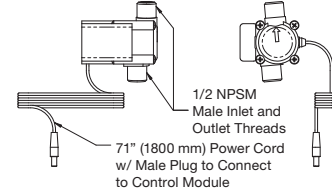

## EC-TMV Thermostatic Mixing Valve

- Thermostatic mixing valve with 1/2" NPSM male fittings
- Tested and certified to ASSE 1070
- Integral check valves built into hot and cold inlets
- Tamper resistant temperature limit stop prevents water from exceeding 120° F (concealed under knob)
- Can be added to any ChekPoint™ faucet; specify with -TMV suffix



To order the standard ChekPoint™ Sensor Faucet models to include the thermostatic mixing valve (add -TMV):

**EC-3100-TMV**  
**EC-3101-TMV**  
**EC-3102-TMV**  
**EC-3103-TMV**  
**EC-3106-TMV**

## EC-FILTER Electronic Faucet

- Replacement filter for ChekPoint™ control module

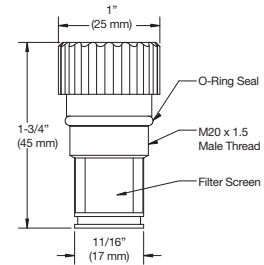

## NEW INSTALLATION OPTIONS!



- Gang-install up to eight faucets to one power supply, saving installation time and money!
- Available for EC-3100, EC-3101, EC-3102 and EC-3103 Series Electronic Faucets

## EC-EASYWIRE ChekPoint™ Installation Kit

- 100-240 VAC Plug-in transformer
- 76" long power cord
- Allows up to eight (8) electronic ChekPoint faucets to be ganged to a single power jack
- Requires one EC-EASYWIRE4CC connector per faucet
- Compliant with CEC Appliance Efficiency Regulations CEC-400-2007-016-REV1



## EC-EASYWIRE4CC ChekPoint™ Installation Kit

- 4' connector cables for EasyWire AC transformer connections in a daisy chain circuit
- One EC-EASYWIRE4CC connector is needed for each additional faucet in chain



## EC-EASYWIRE5EXT ChekPoint™ Installation Kit

- 5' extension cables when additional cable length is needed for connections

## EC-HARDWARE ChekPoint™ Installation Kit

- Electronic AC transformer, input 100-240 VAC, 47-63 Hz
- Terminal block allows you to hardwire up to eight (8) ChekPoint faucets to a single power supply
- Connect to terminals on back of ChekPoint Control Module
- Mounting plate serves as lid for standard size conduit box (box not included)
- Note: wiring supplied by others

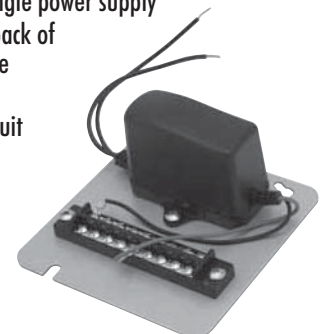



RELIABILITY BUILT IN™

Introducing the T&S Brass

# EC-Hydrogen Series ChekPoint™ Electronic Sensor Faucets with Hydro-Generator

Imagine a faucet which generates and stores its own power through the flow of water, without needing AC or DC back-up!

Our ChekPoint™ Electronic Sensor Faucets – the EC-3100, EC-3101, EC-3102, EC-3103 and EC-3106 series – can all be ordered or easily modified with a hydro-generator – an EC-HYDROGEN Kit. It is one of three power options for the T&S Brass ChekPoint™ product line.

The kit includes a female-to-female 1/2 NPSM swivel adapter, a hydro-generator with 1/2 NPSM inlet and outlet and attached power cord for connection to the existing sensor faucet control module. The use of the T&S ChekPoint™ EC-HYDROGEN and/or T&S ChekPoint™ Electronic Faucets may help qualify towards credits for LEED certification.

## Operation

Imagine having a self-sustaining power source for your ChekPoint™ sensor faucets and no longer needing to rely on batteries or transformers. Hydroelectric power – energy harnessed from moving water – is a form of renewable energy.

Using this principle, our hydro-generator produces energy to power our ChekPoint™ sensor faucets. Water enters the hydro-generator and passes by a turbine causing it to rotate. The hydro-generator uses part of this rotational energy to power the sensor faucets. The remaining energy generated is saved and stored in the hydro-generator for later use. Minimal use of the hydro-generator (5 seconds of usage three times a day at 1 GPM at 60 PSI) is sufficient to accommodate consumed energy and generate and store energy. However, the unit can store power for up to eight months with no cycling.

The average estimated lifespan for EC-Hydrogen is ten years (estimate based on 1 million cycles in lab testing; individual results may differ).

SAVE ENERGY WATER MONEY

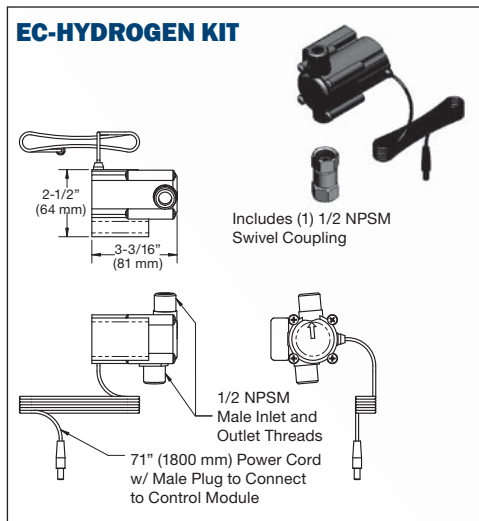

EC-3102-HG





Medical Lavatory Faucets with Adjustable Centers

All models have: • 1/2" O.D. slip inlets • Valves adjustable for angle installation • Teflon seat washers

**B-0865-04**  
Medical Lavatory Faucet

- 5-1/2" (140 mm) spread rigid gooseneck
- 8" (203 mm) centers
- 1/2" NPSM coupling nuts
- Rosespray outlet (B-0103)
- 5-1/16" (129 mm) clearance from deck to face of spray
- 4" (152 mm) wrist action handles (B-WH4)



**B-0866-PV**  
Medical Lavatory Faucet with PV Connection

- 5-1/2" (140 mm) spread swivel gooseneck (133X)
- Swivel/rigid gooseneck spout
- 8" (203 mm) adjustable centers
- Rosespray outlet (B-0103)
- 4-1/4" (108 mm) clearance from deck to rosespray
- 6" (152 mm) wrist action handles (B-WH6)
- Pedal valve connection (B-PV)

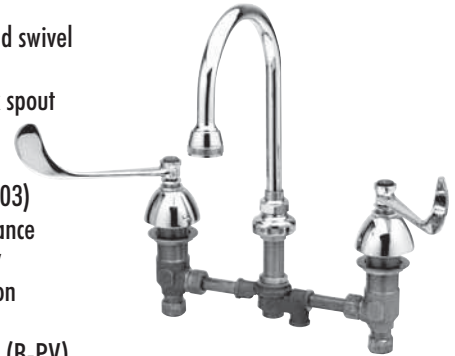

- B-0865-04L** Same as B-0865-04 except with 12" (305 mm) centers
- B-0865** Same as B-0865-04 except with 6" (152 mm) wrist action handles (B-WH6)
- B-0866-04** Same as B-0865-04 except with 5-1/2" (140 mm) spread swivel/rigid gooseneck
- B-0866** Same as B-0865 except with 5-3/4" (146 mm) spread swivel/rigid gooseneck
- B-0867-04** Same as B-0865-04 except with aerator (B-0199-02)
- B-0867-04L** Same as B-0867-04 except with 12" (305 mm) centers
- B-0867-04-WS** Same as B-0867-04 except with low-flow aerator (1.5 GPM)

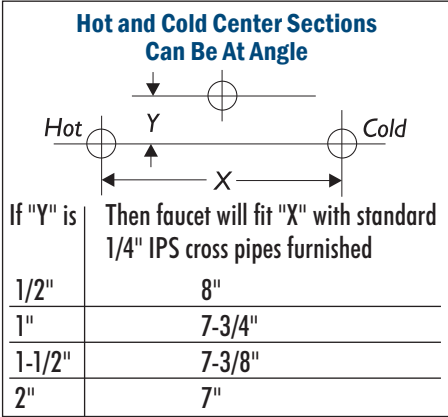

**B-0868-04**  
Medical Lavatory Faucet

- 5-1/2" (140 mm) spread rigid gooseneck (120X)
- 8" (203 mm) centers
- Rosespray outlet (B-0103)
- 5-5/8" (143 mm) clearance from deck to face of spray
- 1/2" NPSM coupling nuts
- 4" (152 mm) wrist action handles (B-WH4)
- Pop-up waste assembly (B-0898)

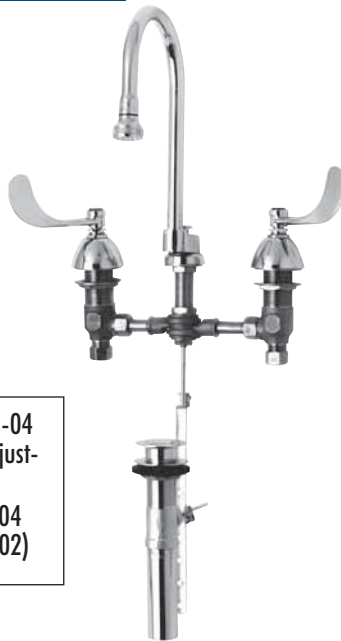

- B-0868-04L** Same as B-0868-04 except with 12" (305 mm) adjustable centers
- B-0869-04** Same as B-0868-04 except with aerator (B-0199-02)

**B-PV**  
Pedal Valve Hot Connection

- Pedal valve connection can be furnished on all B-0865 style faucets
- Allows faucet to be operated with either wrist action handles or foot pedal valve
- To order, indicate "B-PV" suffix after model number
- Pedal valve must be ordered separately

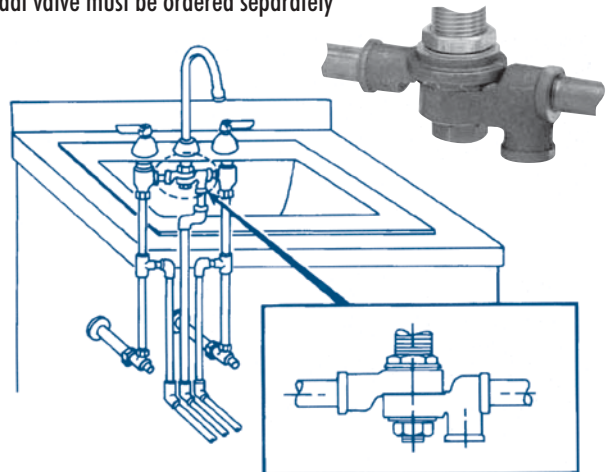

## Medical Lavatory Faucets



All models: **NEW DESIGN** has EasyInstall pre-assembled faucet body for Concealed Widespread Faucets

- Easy installation
- 1/2" O.D. slip inlets
- Teflon seat washers
- 1/2" NPSM coupling nuts

### EasyInstall

#### B-2386 Medical Lavatory Faucet with Swivel Gooseneck

- EasyInstall faucet
- 5" (127 mm) spread swivel gooseneck
- Swivel/rigid gooseneck spout
- 8" (203 mm) centers
- B-0199-01 aerator outlet (2.2 GPM)
- 10" (254 mm) clearance from deck to outlet
- Lever handles



#### B-2865-04 Medical Lavatory Faucet

- EasyInstall faucet
- 5-1/2" (140 mm) spread rigid gooseneck (120X)
- 8" (203 mm) centers
- B-0103 Rosespray outlet
- 5-1/16" (129 mm) clearance from deck to face of spray
- 4" (102 mm) wrist action handles (B-WH4)



PATENTED  
DESIGN  
PATENT  
NUMBER  
7,472,434

**B-2865** Same as B-2865-04 except with 6" (152 mm) wrist action handles (B-WH6)

**B-2865-05-WS** Same as B-2865-05 except with low-flow aerator (1.5 GPM)

#### B-2866-05 Medical Lavatory Faucet

- EasyInstall faucet
- 5-3/4" (146 mm) spread swivel gooseneck
- Swivel/rigid gooseneck spout
- 8" (203 mm) centers
- B-0199-01 non-splash aerator (2.2 GPM)
- 6-1/4" (159 mm) clearance from deck to face of spray
- 4" (102 mm) wrist action handles (B-WH4)



### EasyInstall

#### Related models (not EasyInstall):

**B-2865-04L** Same as B-2865-04 except with 12" (305 mm) centers

**B-2865-05** Same as B-2865-04 except with 12" (305 mm) flexible stainless steel inlet supplies

**B-2865-05CR** Same as B-2865-05 except with ceramic cartridges

**B-2865-05-120XA** Same as B-2865-05 except with 12" flex lines, and B-0199-02 aerator (2.2 GPM)

**B-2865-05-133XA** Same as B-2865-05 except with swivel gooseneck and B-0199-01 aerator (2.2 GPM)

**B-2865-06** Same as B-2865-04 except with 6" (152 mm) centers

**B-2866-01** Same as B-2866-05 except with 8-3/4" (223 mm) spread gooseneck (135X) with stream regulator

**B-2866-01QT-VRF** Same as B-2866-01 except with quarter-turn spindle assemblies and vandal-resistant laminar flow device (2.2 GPM)

**B-2862** Same as B-2866-01 except with B-0199-02 non-splash aerator (2.2 GPM)

**B-2862-WS** Same as B-2862 except with low-flow aerator (1.5 GPM)

**B-2866-05-LF15** Same as B-2866-05 except with laminar flow device (1.5 GPM)

**B-2866-05FC** Same as B-2866-05 except with 5-3/4" spread plain end gooseneck (133XP)

**B-2866-05FC-QT** Same as B-2866-05FC except with quarter-turn spindle assemblies

**B-2866-05QT** Same as B-2866-05 except with quarter-turn spindle assemblies

**B-2866-05QT-VRS** Same as B-2866-05QT except with vandal-resistant aerator and vandal-resistant screws

**B-2866-05QT-WS** Same as B-2866-05QT except with low-flow aerator (1.5 GPM)

**B-2866-05-WS** Same as B-2866-05 except with low-flow aerator (1.5 GPM)



## Medical Lavatory Faucets

All models: **NEW DESIGN** has EasyInstall pre-assembled faucet body for Concealed Widespread Faucets

- Easy installation
- 1/2" O.D. slip inlets
- Teflon seat washers
- 1/2" NPSM coupling nuts

### EasyInstall

#### B-2347 Medical Lavatory Faucet

- EasyInstall faucet
- 8-13/16" (224 mm) spread swivel gooseneck
- Sidespray with automatic diverter and 4' flexible reinforced hose
- 8" (203 mm) centers
- 3/8" NPSM female outlet with rosespray
- 6-5/16" (160 mm) clearance from deck to face of spray
- 4" (102 mm) wrist action handles (B-WH4)

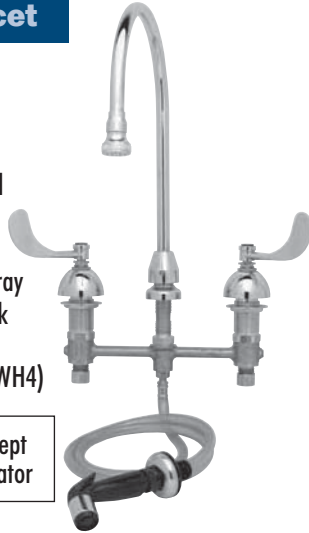

**B-2347-05-LVR** Same as B-2347 except with lever handles and 2.2 GPM aerator

#### B-2866-04 Medical Lavatory Faucet

- EasyInstall faucet
- 5-3/4" (146 mm) spread swivel gooseneck
- Swivel/rigid gooseneck spout
- 8" (203 mm) centers
- Rosespray outlet (B-0103)
- 5-7/8" (149 mm) clearance from deck to face of spray
- 4" (102 mm) wrist action handles (B-WH4)

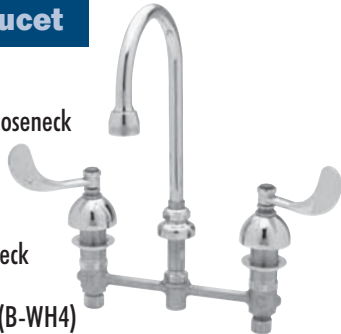

**B-2866-04-01QT** Same as B-2866-04 except with quarter-turn spindle assemblies and swivel gooseneck 4-5/16" spread with aerator (2.2 GPM)

**B-2866-04VRS** Same as B-2866-04 except with 8-3/4" (223 mm) spread swivel gooseneck (135X) and vandal-resistant aerator (B-0199-07) and vandal-resistant screws

**B-2866-04L** Same as B-2866-04 except with stream regulator on gooseneck and 12" (305 mm) centers

**B-2866** Same as B-2866-04 except with 6" wrist-action handles (B-WH6)

**B-2866-F05** Same as B-2866 except with non-aerated spray device (0.5 GPM)

**B-2866-LF12-CR4** Same as B-2866 except for ceramic cartridges and flow tower outlet (1.2 GPM)

**B-2866-QT-21VR** Same as B-2866 except with quarter-turn spindle assemblies and B-0199-21-VRF vandal-resistant laminar flow aerator (2.2 GPM)

**B-2866-QT-VF05** Same as B-2866-QT-21VR except with vandal-resistant outlet device (0.5 GPM)

**B-2866-QT-VF05G** Same as B-2866-QT-VF05 except with gaskets

**B-2866-VF05** Same as B-2866 except with vandal-resistant non-aerated spray device (0.5 GPM)

#### B-2867-04 Medical Lavatory Faucet

- EasyInstall faucet
- 5-9/16" (141 mm) spread rigid gooseneck (120X)
- 8" (203 mm) centers
- Non-splash aerator (B-0199-02)
- 5-5/16" (135 mm) clearance from deck to face of spray
- 4" (102 mm) wrist action handles (B-WH4)

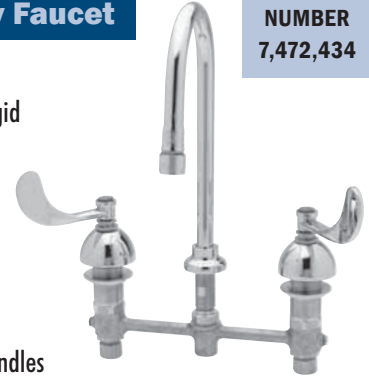

PATENTED  
DESIGN  
PATENT  
NUMBER  
7,472,434

**B-2867** Same as B-2867-04 except with 6" (152 mm) wrist action handles (B-WH6)

**B-2867-04-F05** Same as B-2867-04 except with non-aerated spray device (0.5 GPM)

**B-2867-04-LF15** Same as B-2867-04 except with laminar flow device (1.5 GPM)

**B-2867-04-VF05** Same as B-2867-04 except with 0.5 GPM vandal-resistant non-aerated spray device

**B-2867-04-WS** Same as B-2867-04 except with low-flow aerator (1.5 GPM)

#### Related model (not EasyInstall):

**B-2867-04L** Same as B-2867-04 except with 12" (305 mm) centers; not EasyInstall faucet

#### B-2868-04 Medical Lavatory Faucet with Pop-Up Valve

- EasyInstall faucet
- 5-1/2" (140 mm) spread rigid gooseneck (120X)
- 8" (203 mm) centers
- Rosespray outlet (B-0103)
- 5-5/8" (143 mm) clearance from deck to face of spray
- 4" (102 mm) wrist action handles (B-WH4)
- Pop-up waste (B-0898)

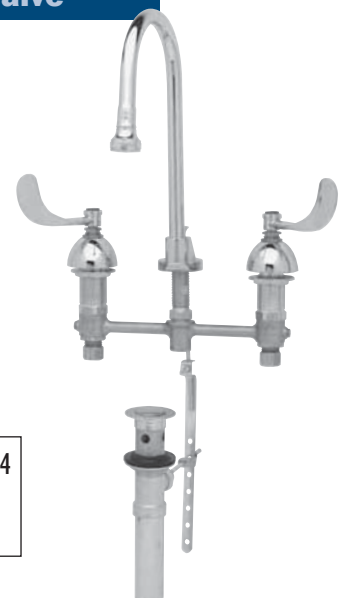

**B-2869-04** Same as B-2868-04 except with aerator outlet (2.2 GPM)

## Medical Lavatory Faucets

- All models have:
- 4" (102 mm) centers
  - 15/16" (23 mm) diameter top shoulder to fit 1" (25 mm) diameter hole in basin
  - 1/2" NPS shanks
  - Fit sinks up to 1-3/8" (34 mm) thick
  - 1/2" O.D. slip inlets



ADA Compliant

### B-0892 Medical Lavatory Faucet with Rigid Gooseneck



- 6-5/8" (168 mm) clearance from deck to aerator
- 4" (102 mm) from centerline to center of outlet
- Rigid gooseneck with 2-3/4" (70 mm) spread (005028-40)
- B-0199-01 aerator outlet (2.2 GPM)
- Standard Eterna cartridges
- 4" (102 mm) wrist action handles (B-WH4) with color coded indexes
- 1/2" NPT coupling nuts

MODEL	CARTRIDGE	GOOSENECK	HEIGHT	CLEARANCE	SPREAD	OUTLET	GPM	HANDLE	V-R	NOTES
B-0892	Eterna	Rigid	10-7/16"	6-5/8"	2-3/4"	B-0199-01 aerator	2.2 GPM	4" Wrist Action (B-WH4)	N	
B-0892-01	Eterna	Rigid	10-1/8"	6-3/16"	4-1/16"	B-0199-02 aerator	2.2 GPM	4" Wrist Action	N	
B-0892-01-CR	Ceramic	Rigid	10-1/8"	6-1/8"	4-1/16"	B-0199-02 aerator	2.2 GPM	4" Wrist Action	N	
B-0892-01-WS	Eterna	Rigid	10-1/8"	6-3/16"	4-1/16"	B-0199-01-WS	1.5 GPM	4" Wrist Action	N	WaterSense aerator
B-0892-122X-LAM	Eterna	Rigid	12-3/8"	7"	5-1/2"	B-0199-21 laminar flow device	2.2 GPM	4" Wrist Action	N	
B-0892-CR	Ceramic	Rigid	10-7/16"	6-11/16"	2-3/4"	B-0199-01 aerator	2.2 GPM	4" Wrist Action	N	
B-0892-FC	Eterna with flow control	Rigid	8-15/16"	5-11/16"	2-5/8"	Plain end outlet		4" Wrist Action	N	0.7 GPM flow control in cartridge
B-0892-F1-CR-SC	Ceramic with check valves	Rigid	10-3/8"	6-5/8"	2-3/4"	B-0199-01-F10 aerator	1.0 GPM	4" Wrist Action	N	
B-0892-LF22	Eterna	Rigid	10-7/16"	6-5/8"	2-3/4"	B-0199-21 laminar flow device	2.2 GPM	4" Wrist Action	N	
B-0892-M B-0892 Master Box (6)	Eterna	Rigid			2-3/4"	B-0199-01 aerator	2.2 GPM	4" Wrist Action	N	Master carton of 6
B-0892-VF05	Eterna	Rigid	10-7/16"	6-11/16"	2-3/4"	B-0199-06-N05	0.5 GPM	4" Wrist Action	Y	Includes vandal-resistant key
B-0892-VRS	Eterna	Rigid	10-3/8"	6-5/8"	2-3/4"	B-0199-06 vandal-resistant aerator	2.2 GPM	4" Wrist Action	Y	Vandal-resistant screws in handles; includes V-R key
B-0892-CR-LF05	Ceramic	Rigid	10-7/16"	6-3/4"	2-3/4"	B-0199-01-N05	0.5 GPM	4" Wrist Action	N	
B-0892-CR-WS	Ceramic	Rigid	10-7/16"	6-11/16"	2-3/4"	B-0199-01-WS	1.5 GPM	4" Wrist Action	N	WaterSense aerator
B-0892-F05	Eterna	Rigid	10-7/16"	6-11/16"	2-3/4"	B-0199-01-N05	0.5 GPM	4" Wrist Action	N	
B-0892-WS	Eterna	Rigid	10-7/16"	6-11/16"	2-3/4"	B-0199-01-WS	1.5 GPM	4" Wrist Action	N	WaterSense aerator
B-0893	Eterna	Rigid			2-3/4"	B-0199-01 aerator	2.2 GPM	4" Wrist Action	N	Includes pop-up waste assembly (B-0898)

V-R Vandal-resistant



## Medical Lavatory Faucets

- All models have:
- 4" (102 mm) centers
  - 15/16" (23 mm) diameter top shoulder to fit 1" (25 mm) diameter hole in basin
  - 1/2" NPS shanks
  - Fit sinks up to 1-3/8" (34 mm) thick
  - 1/2" O.D. slip inlets



ADA Compliant

### B-0892-01QT Medical Lavatory Faucet with Swivel Gooseneck

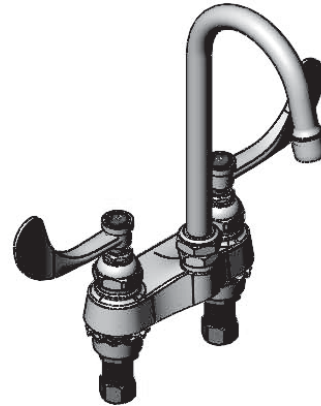

- 7-1/4" (184 mm) clearance from deck to aerator
- 4" (102 mm) from centerline to center of outlet
- Swivel gooseneck with 4-3/8" (111 mm) spread (017907-45)
- B-0412 rigid to swivel adapter
- Optional swivel/rigid washer included
- B-0199-01 aerator outlet (2.2 GPM)
- Quarter-turn Eterna spindle assemblies
- 4" (102 mm) wrist action handles (B-WH4) with color coded indexes
- 1/2" NPT coupling nuts

MODEL	CARTRIDGE	GOOSENECK	HEIGHT	CLEARANCE	SPREAD	OUTLET	GPM	HANDLE	V-R	NOTES
B-0892-01QT	Eterna (Quarter-turn)	Swivel /Rigid	10-7/8"	7-1/4"	4-3/8"	B-0199-01 aerator	2.2 GPM	4" Wrist Action	N	
B-0892-01CR-22	Eterna (Quarter-turn)	Swivel /Rigid	10-7/8"	7-1/4"	4-3/8"	B-0199-21 laminar flow device	2.2 GPM	4" Wrist Action	N	
B-0892-133X	Eterna	Swivel	12-3/16"	8-3/16"	5-11/16"	B-PT stream regulator outlet		4" Wrist Action	N	
B-0892-135X	Eterna (Quarter-turn)	Swivel /Rigid	13-7/8"	6-7/8"	8-13/16"	B-0199-21 laminar flow device	2.2 GPM	4" Wrist Action	N	
B-0892-CR-HW	Ceramic	Swivel	10-7/8"	7-11/16"	4-1/4"	B-PT stream regulator outlet		4" Wrist Action	N	With B-0412-F12 adapter with flow control tower (1.2 GPM)
B-0892-QT-F05	Eterna (Quarter-turn)	Swivel /Rigid	10-7/8"	7-1/4"	4-3/8"	B-0199-01-N05 non-aerated spray device	0.5 GPM	4" Wrist Action	N	
B-0892-LF12-CR4	Ceramic	Swivel	13"	8-7/8"	5-11/16"	B-PT stream regulator outlet		4" Wrist Action	N	With B-0412-F12 adapter with flow control tower (1.2 GPM)
B-0892-LN-QT	Eterna (Quarter-turn)	Swivel	Less nozzle	Less nozzle	Less nozzle	Less nozzle	Less nozzle	4" Wrist Action	N	Less nozzle
B-0892-LN	Eterna	Swivel	Less nozzle	Less nozzle	Less nozzle	Less nozzle	Less nozzle	4" Wrist Action	N	Less nozzle
B-0892-QT-LF16	Eterna (Quarter-turn)	Swivel /Rigid	10-7/8"	7-11/16"	4-1/4"	B-PT stream regulator outlet		4" Wrist Action	N	With B-0412-F16 adapter with flow control tower (1.6 GPM)
B-0892-QT-VF05	Eterna (Quarter-turn)	Swivel /Rigid	10-7/8"	7-1/4"	4-3/8"	B-0199-06-N05 V-R non-aerated spray device	0.5 GPM	4" Wrist Action	Y	
B-0892-QT-VF05G	Eterna (Quarter-turn)	Swivel /Rigid	10-15/16"	7-5/16"	4-3/8"	B-0199-06-N05 V-R non-aerated spray device	0.5 GPM	4" Wrist Action	Y	Deck gasket
B-0892-QT-WS	Eterna (Quarter-turn)	Swivel /Rigid	10-7/8"	7-1/4"	4-1/4"	B-0199-01-WS	1.5 GPM	4" Wrist Action	N	WaterSense aerator

V-R Vandal-resistant





Lavatory Faucets

**NEW DESIGN** has EasyInstall pre-assembled faucet body for Concealed Widespread Faucets

- Easy installation
- 1/2" O.D. slip inlets
- Teflon seat washers
- 1/2" NPSM coupling nuts

**EasyInstall**

**B-2850 Lavatory Faucet**

- EasyInstall faucet
- 5-1/2" (140 mm) spread rigid gooseneck (120X)
- 8" (203 mm) standard centers
- Lever handles
- Stream regulator outlet (B-LT)
- 5-3/4" (146 mm) clearance from deck to tip of outlet
- 1/2" NPSM coupling nuts



- B-2850-01** Same as B-2850 except with 4" (102 mm) wrist action handles and laminar flow device (2.2 GPM)
- B-2851** Same as B-2850 except with swivel/rigid swivel gooseneck 5-11/16" spread (133X) spout
- B-2851-133X-VR** Same as B-2851 except with vandal-resistant handles and vandal-resistant laminar flow device (2.2 GPM)
- B-2852** Same as B-2850 except with swivel gooseneck (135X) and non-splash aerator (2.2 GPM)
- B-2850-F05** Same as B-2850 except with non-aerated spray device (0.5 GPM)
- B-2850-VF05** Same as B-2850 except with vandal-resistant non-aerated spray device (0.5 GPM)
- B-2850-WH4** Same as B-2850 except with 4" (102 mm) wrist action handles
- B-2850-WS** Same as B-2850 except with low-flow aerator (1.5 GPM)

**Related models (not EasyInstall):**

- B-2850-L** Same as B-2850 except with 12" (305 mm) standard centers
- B-2851-L** Same as B-2851 except with 12" (305 mm) standard centers
- B-0850** Same as B-2850 – has valves adjustable for angle installation

**B-2853-RSW-061X Lavatory Faucet**

- EasyInstall faucet
- 10" (254 mm) restricted swing nozzle adapter with B-0199-06F-05 (0.5 GPM) vandal resistant aerator
- 8" (203 mm) standard centers
- Lever handles
- 4-1/4" (108 mm) clearance from deck to tip of outlet
- 1/2" NPSM coupling nuts

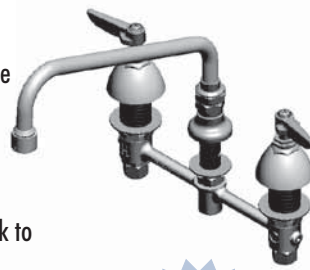

- B-2853-RSW-VR05** Same as B-2853-RSW-061X except with rigid to swivel 90° restricted gooseneck, B-0199-06F-05 vandal resistant aerator (0.5 GPM), 9-1/2" (283 mm) clearance from outlet to deck, 7-1/8" (180 mm) spread

**B-2855 Lavatory Faucet**

- EasyInstall faucet
- 9" (229 mm) swing nozzle (166X)
- Swivel/rigid swing nozzle
- 8" (203 mm) standard centers
- Stream regulator outlet (B-PT)
- 6-1/4" (159 mm) clearance from deck to tip of outlet
- 1/2" NPSM coupling nuts



**PATENTED DESIGN PATENT NUMBER 7,472,434**

- B-2855-01** Same as B-2855 except with B-0199-29 laminar flow device (1.5 GPM)
- B-2855-WS** Same as B-2855 except with low-flow aerator (1.5 GPM)

**Related model (not EasyInstall):**

- B-0855** Same as B-2855 – has valves adjustable for angle installation

**B-2859 Medical Lavatory Faucet**

**NEW MODEL!**

- EasyInstall faucet
- Swing nozzle (B-2387) with B-0199-01 aerator (2.2 GPM)
- Swivel deck flange
- 8" (203 mm) centers
- Compression cartridges
- 3/8" NPSM female outlet with rosespray
- 8-9/16" (218 mm) clearance from deck to face of aerator
- 4" (102 mm) wrist action handles (B-WH4)



**B-2885 Lavatory Faucet**

- EasyInstall faucet
- 5-1/2" (140 mm) spread rigid gooseneck (120X)
- 8" (203 mm) standard centers
- Stream regulator outlet (B-LT)
- 6-7/16" (163 mm) clearance from deck to tip of outlet
- Pop-up waste assembly (B-0898)
- 1/2" NPSM coupling nuts



**Related model (not EasyInstall):**

- B-0885** Same as B-2885 except with valves adjustable for angle installation

## Lavatory Faucets

**NEW MODELS!**



All models: **NEW DESIGN** has EasyInstall pre-assembled faucet body for Concealed Widespread Faucets

- Easy installation
- 1/2" O.D. slip inlets
- Teflon seat washers
- 1/2" NPSM coupling nuts

### B-2990 Lavatory Faucet

**Easy Install**

- EasyInstall Faucet
- 5" (127 mm) cast basin spout
- 8" (203 mm) centers
- 2" (51 mm) clearance from deck to aerator
- 1/2" NPSM coupling nuts on inlets
- Lever handles



**New Water-Saving Models**

- B-2990-175F** Same as B-2990 except with four arm handles
- B-2990-180F** Same as B-2990 except with dome handles
- B-2990-P** Same as B-2990 except with pop-up assembly (B-898)
- B-2990-PWH4** Same as B-2990-P except with 4" (102 mm) wrist action handles
- B-2990-WH4** Same as B-2990 except with 4" (102 mm) wrist action handles
- B-2990-WH4-QT** Same as B-2990-WH4 except with quarter-turn spindle assemblies
- B-2990-WH4-WS** Same as B-2990-WH4 except with low-flow aerator (1.5 GPM)
- B-2990-F05** Same as B-2990 except with non-aerated spray device (0.5 GPM)
- B-2990-VF05** Same as B-2990 except with vandal-resistant non-aerated spray device (0.5 GPM)
- B-2990-WS** Same as B-2990 except with low-flow aerator (1.5 GPM)

**Related model (not EasyInstall):**

- B-2990-FL** Same as B-2990 except with flexible supply lines

### B-2955 Lavatory Faucet

**Easy Install**

- 9" (229 mm) swing nozzle (166X)
- Swivel/rigid swing nozzle
- 8" (203 mm) standard centers
- Stream regulator (B-LT)
- 6-5/16" (160 mm) clearance from deck to tip of outlet
- 1/2" NPSM coupling nuts
- Dome handles



**PATENTED DESIGN PATENT NUMBER 7,472,434**

### B-2992 Lavatory Faucet

- Swivel joint faucet body for angle installation
- 5" (127 mm) cast basin spout
- 8" (203 mm) centers
- 2" (51 mm) clearance from deck to aerator
- 1/2" NPSM coupling nuts on inlets
- Lever handles (175F)

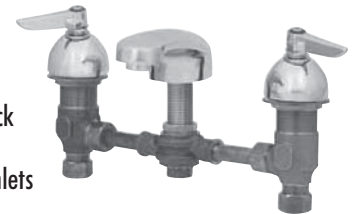

**Note:** this is not an EasyInstall faucet

- B-2992-180F** Same as B-2992 except with dome handles
- B-2992-L** Same as B-2992-WH4 except with 12" (305 mm) centers
- B-2992-P** Same as B-2992 except with pop-up assembly (B-0898)
- B-2992-PWH4** Same as B-2992-P except with 4" (102 mm) wrist action handles
- B-2992-WH4** Same as B-2992 except with 4" (102 mm) wrist action handles

### B-2320 Medical Lavatory Faucet

- Swivel gooseneck with 2.2 GPM aerator
- Rigid to swivel adapter
- 4-1/8" (105 mm) clearance from deck to outlet
- Eterna cartridges
- Lever handles
- 1/2" NPSM coupling nuts

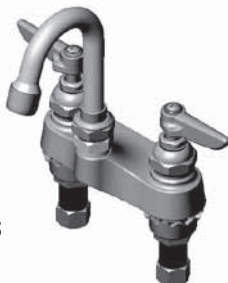

### B-0898 Pop-Up Waste Assembly

- Cast brass drain body
- Vandal resistant stopper
- 1-1/4" (32 mm) diameter 17 gage tailpiece
- Fits sinks with 1-7/16" (36.5 mm) to 1-3/4" (44 mm) diameter drain hole

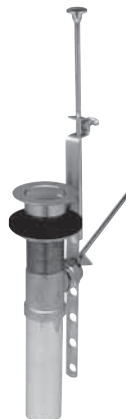

### B-0898-OF Offset Drain

- ADA compliant
- Polished chrome plated bronze body
- Captive grid
- 1-1/4" (32 mm) diameter 17 gage tailpiece



### B-0899 Drain with Grid

- Cast brass polished chrome plated grid
- Captive grid
- 1-1/4" (32 mm) diameter 17 gage tailpiece



## Centerset Faucets with or without Pop-Up Assembly

**NEW MODELS!**



- All models have:
- 1/2" O.D. slip inlets
  - 15/16" dia. top shank
  - 1/2" NPS thread on shanks
  - Fit sinks up to 1-3/8" (34 mm) thick
  - 1/2" NPSM coupling nuts

### B-0870 Centerset Lavatory Faucet

- 3-3/4" (95 mm) from inlet of faucet to outlet
- 4" (102 mm) centers
- B-0199-03 aerator (2.2 GPM)
- 1-7/16" (27 mm) clearance from deck to aerator
- Pop-up waste assembly (B-0898)



- B-0870-CR** Same as B-0870 except with cerama cartridges
- B-0871** Same as B-0870 except without pop-up assembly
- B-0871-M** B-0871 Master Box (6)
- B-0871-VRS** Same as B-0871 except with vandal resistant screws in handles and B-0199-08 vandal resistant aerator (2.2 GPM)
- B-0871-CR** Same as B-0871 except with cerama cartridges
- B-0871-CR-PRISON** Same as B-0871 except with vandal resistant lever handles, vandal-resistant flow control (1.0 GPM) aerator and ceramic cartridges
- B-0871-CR-WS** Same as B-0871-CR except with low-flow aerator (1.5 GPM)
- B-0871-F05** Same as B-0871 except with non-aerated spray device (0.5 GPM)
- B-0871-VF05** Same as B-0871 except with vandal-resistant non-aerated spray device (0.5 GPM)
- B-0871-VR-CH-QT** Same as B-0871 except with vandal-resistant aerator (2.2 GPM), club handles, vandal-resistant screws and quarter-turn Eterna cartridges
- B-0871-WS** Same as B-0871 except with low-flow aerator (1.5 GPM)

**New Vandal Resistant Model**

**New Water-Saving Models**

### B-0873 Centerset Lavatory Faucet

- Rigid 2-3/4" (70 mm) spread gooseneck (119X)
- 4" (102 mm) centers
- B-0199-02 aerator (2.2 GPM)
- 5" (127 mm) clearance from deck to aerator
- Pop-up waste assembly (B-0898)



- B-0874** Same as B-0873 except without pop-up assembly
- B-0874-M** B-0774 Master Box (6)

### B-0877 Centerset Lavatory Faucet

- 3-3/4" (95 mm) from inlet of faucet to outlet
- 4" (102 mm) centers
- 1-1/4" (32 mm) diameter spray face
- 1-13/16" (46 mm) clearance from deck to outlet

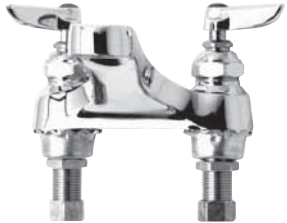

### B-2970 Lavatory Faucet

- 3-3/4" (95 mm) from inlet of faucet to outlet
- 4" (102 mm) centers
- B-0199-03 aerator (2.2 GPM)
- 1-1/2" (38 mm) clearance from deck to aerator
- Pop-up waste assembly (B-0898)

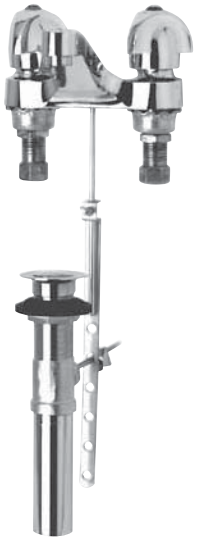

- B-2971** Same as B-2970 except without pop-up assembly



## Pivot Action Metering Faucets

- All models:
- ADA compliant according to ICC/ANSI A117.1-2003
  - Less force required to activate faucet
  - Load tested to 150 lbs. of force to meet the most demanding applications

### B-0712-PA Pivot Action Metering Faucet

- 1/2" NPS male shank
- 1/4" IPS union tailpiece
- 4-1/8" (105 mm) center of faucet to center of spout
- Spout 1-1/4" (27 mm) above deck
- Vandal resistant
- Aerator (2.2 GPM)
- 10° angle on aerator



### B-0807-PA Pivot Action Metering Faucet

- 1/2" NPT threaded shank with 1/4" NPT tailpieces on 4" (102 mm) centers
- Fits sinks up to 1-3/8" (34 mm) thick
- 1/2" O.D. slip inlet
- 4-3/16" (107 mm) high
- Specify hot, cold or blank
- B-0199-02 aerator (2.2 GPM)
- 4" (102 mm) spreader assembly with volume controls



### B-0837-PA Pivot Action Metering Faucet

- 3-3/4" (95 mm) from inlet of faucet to outlet
- 4" (102 mm) centers
- Spray face outlet
- 2" (51 mm) clearance from deck to outlet



### B-0800-PA Pivot Action Metering Wash Sink Single Temperature Faucet

- Wall-mount with 1/2" NPT female inlet
- 1-1/4" diameter rose spray
- 6-3/4" (171 mm) overall length
- 3-7/8" (99 mm) from wall to center of outlet



### B-0805-PA Pivot Action Metering Single Temperature Faucet

- 1/2" NPT threaded shank
- Fits sinks up to 1-3/8" thick
- Fits 1/2" O.D. slip inlet
- 4-3/16" (107 mm) high
- B-0199-02 aerator outlet (2.2 GPM)



### B-0831-PA Pivot Action Metering Lavatory Faucet

- 4-5/16" (110 mm) from inlet of faucet to outlet
- 4" (102 mm) centers
- B-0199-03 aerator (2.2 GPM)
- 1-1/2" (38 mm) clearance from deck to aerator



### B-2490-PA Pivot Action Metering Faucet

- 4-1/8" (105 mm) from center of faucet to center of outlet
- Single hole with 4" (102 mm) spreader unit
- Supplied with nut and tailpiece for optional 1/4" NPT connection
- 4" (102 mm) spreader assembly with volume controls
- Aerator (2.2 GPM)





**Pivot Action Metering Faucets**

**NEW MODELS!**



**NEW DESIGN** has EasyInstall pre-assembled faucet body for Concealed Widespread Faucets

- Easy installation
- 1/2" O.D. slip inlets
- Teflon seat washers
- 1/2" NPSM coupling nuts

**B-2820-PA  
Concealed Body Lavatory Faucet**

- EasyInstall faucet
- 6" (152 mm) spread rigid gooseneck (120X)
- 8" (203 mm) standard centers
- Stream regulator outlet (B-LT)
- 5-11/16" (145 mm) clearance from deck to tip of outlet



**EasyInstall**

**B-2991-PA  
Pivot Action Metering Valve Lavatory Faucet**

- EasyInstall faucet
- 5" (127 mm) cast basin spout
- 8" (203 mm) centers
- 2" (51 mm) clearance from deck to aerator
- 1/2" NPSM coupling nuts on inlets
- Aerator (2.2 GPM)



**PATENTED DESIGN  
PATENT NUMBER  
7,472,434**

**Slow Self-Closing Metering Faucets**

- All models:
- Provide adjustable, timed flow of water
  - ADA compliant
  - Vandal resistant
  - Require less than 5 lbs. operating force to open
  - Remain open for 10 seconds minimum



**B-0800  
Slow Self-Closing Wash Sink Single Temperature Faucet**



- Wall-mount with 1/2" NPT female inlet
- 1-1/4" diameter rosespray
- 6-1/2" (165 mm) overall length
- 4" (102 mm) from wall to center of outlet

**B-0805  
Slow Self-Closing Single Temperature Faucet**



- 1/2" NPT threaded shank
- Fits sinks up to 1-3/8" thick
- Fits 1/2" O.D. slip inlet
- 5-1/2" (140 mm) high
- Specify hot, cold or blank
- B-0199-02 aerator outlet (2.2 GPM)

**New Water-Saving Models**

- B-0805-VR-LDP** Same as B-0805 except with vandal-resistant aerator (2.2 GPM)
- B-0805-WS** Same as B-0805 except with low-flow aerator (1.5 GPM)
- B-0806** Same as B-0805 except with rose spray outlet
- B-0805-01** Same as B-0805 except with B-WH4 4" (102 mm) wrist action handle (inset, left)
- B-0805-F05** Same as B-0805 except with non-aerated spray device (0.5 GPM)
- B-0805-VF05** Same as B-0805 except with vandal-resistant non-aerated spray device (0.5 GPM)
- B-0806-DP-F20** Same as B-0806 except with deck plate and flow control rosespray (2.0 GPM)



**B-0807  
Slow Self-Closing Mixing Faucet**



- 1/2" NPT threaded shank with 1/4" NPT tailpieces on 4" (102 mm) centers
- Fits sinks up to 1-3/8" (34 mm) thick
- 1/2" O.D. slip inlet
- 5-1/2" (140 mm) high
- Specify hot, cold or blank
- B-0199-02 aerator outlet (2.2 GPM)

- B-0807-WS** Same as B-0807 except with low-flow aerator (1.5 GPM)
- B-0808** Same as B-0807 except with rose spray outlet
- B-0842** Same as B-0807 except with compression cartridge and B-WH4 4" (102 mm) wrist action handle
- B-0807-01** Same as B-0807 except with B-WH4 4" (102 mm) wrist action handle (inset, below)





## Slow Self-Closing Metering Faucets

- All models:
- Provide adjustable, timed flow of water
  - Require less than 5 lbs. operating force to open
  - ADA compliant
  - Remain open for 10 seconds minimum
  - Vandal resistant

### B-0712 Push Button Metering Faucet

- 1/2" NPS male shank
- 1/4" IPS union tailpiece
- 4-1/8" (105 mm) center of faucet to center of spout
- Spout 1-1/4" (31 mm) above deck
- Vandal resistant
- 10° angle on aerator
- B-0199-02 aerator (2.2 GPM)



New  
Water-Saving  
Models

- B-0712-01** Same as B-0712 except with 4" (102 mm) wrist action handle (see p. D26 – new model number: B-0712-WA)
- B-0712-4DP** Same as B-0712 except with 4" (102 mm) forged deckplate
- B-0712-ESC** Same as B-0712 except with escutcheon plate
- B-0712-WS** Same as B-0712 except with low-flow aerator (1.5 GPM)
- B-0713** Same as B-0712 except with B-0199-08 aerator
- B-0712-01VRS** Same as B-0712 except with lever handle and vandal-resistant handle index
- B-0712-F05** Same as B-0712 except with non-aerated spray device (0.5 GPM)
- B-0712-VF05** Same as B-0712 except with vandal-resistant non-aerated spray device (0.5 GPM)

### B-0830 Slow Self-Closing Centerset Lavatory Faucet with Pop-Up

- 3-3/4" (95 mm) from inlet of faucet to outlet
- 4" (102 mm) centers
- B-0199-03 aerator (2.2 GPM)
- 1-5/8" (41 mm) clearance from deck to aerator



- B-0831** Same as B-0830 except without pop-up assembly
- B-0831-01** Same as B-0831 except is wrist action metering faucet with B-WH4 4" handles (see p. D26 – new model number: B-0831-WA)
- B-0831-WS** Same as B-0831 except with low-flow aerator (1.5 GPM)
- B-0831-F05** Same as B-0831 except with 0.5 GPM non-aerated spray device
- B-0831-VF05** Same as B-0831 except with 0.5 GPM vandal-resistant non-aerated spray device
- B-0831-VR** Same as B-0831 except with vandal-resistant aerator (2.2 GPM)

New  
Water-Saving  
Models

### B-0833 Slow Self-Closing Centerset Lavatory Faucet with Pop-Up

- 4" (102 mm) from inlet of faucet to outlet
- 4" (102 mm) centers with push-button metering cartridges/handles
- B-0199-02 aerator (2.2 GPM)
- 5-3/8" (137 mm) clearance from deck to aerator

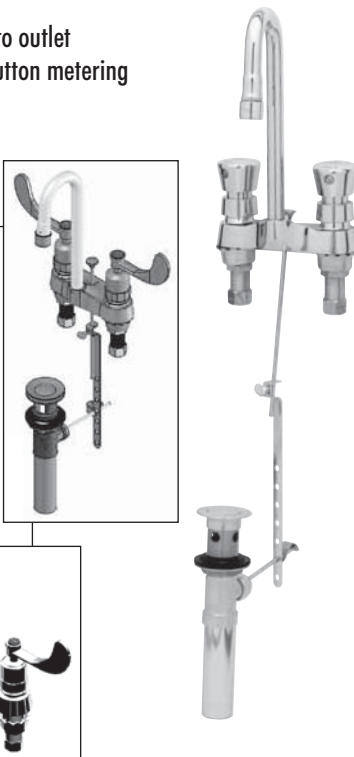

- B-0833-01** Same as B-0833 except with wrist action metering cartridges with 4" (102 mm) wrist action handles (shown, right)
- B-0834** Same as B-0833 except without pop-up assembly
- B-0834-01** Same as B-0834 except with wrist action metering cartridges with 4" (102 mm) handles, and without pop-up assembly (shown, right)

## NEW! Slow Self-Closing Metering Faucet with Temperature Adjustment

### B-2760-H Temperature Adjustable Metering Faucet

New  
Water-Saving  
Model

- 4" centerset lavatory faucet with slow-closing metering/temperature selection
- 0.5 GPM aerator saves water
- Brass, bronze, stainless steel parts with heavy-duty cast brass body
- Blade type handle requires only 5 lbs. pressure to operate
- Users can select only cold water to save energy
- Adjustable time flow can be set to less than 30 seconds
- Vandal-resistant design
- Easily adjust water temperature by turning handle; closes automatically when released







## Slow Self-Closing Metering Faucets

- All models:
- Provide adjustable, timed flow of water
  - ADA compliant
  - Vandal resistant
  - Require less than 5 lbs. operating force to open
  - Remain open for 10 seconds minimum

### B-0836 Slow Self-Closing Centerset Lavatory Faucet with Pop-Up

- Slow self-closing centerset lavatory faucet with pop-up waste assembly
- 3-3/4" (95 mm) from inlet of faucet to outlet
- 4" (102 mm) centers
- Spray face
- 2" (51 mm) clearance from deck to outlet



**B-0836-01** Same as B-0836 except with wrist action metering cartridges with 4" (102 mm) handles

**B-0837** Same as B-0836 except without pop-up assembly

**B-0837-01** Same as B-0837 except with wrist action metering cartridges with 4" (102 mm) handles, and without pop-up assembly



### B-2821 Concealed Body Lavatory Faucet

- EasyInstall faucet
- Slow self-closing lavatory faucet with pop-up waste assembly
- 6" (152 mm) spread rigid gooseneck (120X)
- 8" (203 mm) standard centers
- Stream regulator outlet (B-LT)
- 5-1/4" (133 mm) clearance from deck to tip of outlet

**EasyInstall**



**B-2821-01** Same as B-2821 except with slow close metering cartridges and B-WH4 4" (102 mm) wrist action handles (shown below, inset)

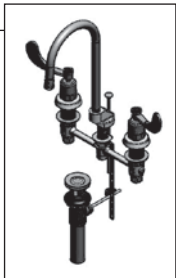

### B-2490 Slow Self-Closing Metering Valve

- Slow self-closing metering valve with push-button cap
- 4" (102 mm) from center of faucet to center of spout
- Single hole with 4" spreader unit
- Supplied with nut and tailpiece for optional 1/4" NPT connection



### B-2820 Concealed Body Lavatory Faucet

- EasyInstall faucet
- Slow self-closing lavatory faucet
- 6" (152 mm) spread rigid gooseneck (120X)
- 8" (203 mm) standard centers
- Stream regulator outlet (B-LT)
- 5-1/2" (140 mm) spread (120X) rigid gooseneck

**EasyInstall**

**PATENTED  
DESIGN  
PATENT  
NUMBER  
7,472,434**



**B-2820-01** Same as B-2820 except with slow close metering cartridges and B-WH4 4" (102 mm) wrist action handles (shown inset, right)

**B-2820-PA** Same as B-2820 except with pivot action metering cartridge/handles (see page D22)



### B-2991 Lavatory Faucet

- EasyInstall faucet
- Slow-self-closing metering cartridges
- 5" (127 mm) cast basin spout
- 8" (203 mm) centers
- 2" (51 mm) clearance from deck to aerator
- 1/2" NPSM coupling nuts on inlets

**EasyInstall**



**B-2823-02** Same as B-2991 except with .5 GPM aerator

**B-2991-P** Same as B-2991 except with pop-up assembly (B-0898)

**B-2991-WH4** Same as B-2991 except with 4" (102 mm) wrist action handles (see p. D26 – new model number: B-2991-WA)

**B-2991-WS** Same as B-2991 except with low-flow aerator (1.5 GPM)

**New  
Water-  
Saving  
Models**

**NEW! Slow Self-Closing Metering Faucets with Wrist Action Handles (-WA)**

- All models: • Provide adjustable, timed flow of water • ADA compliant • Conserves water  
 • Require less than 5 lbs. operating force to open • Remain open for 10 seconds minimum



**B-0712-WA  
Wrist Action Metering Faucet**



- Single temperature basin faucet
- Wrist action metering cartridge with 4" (102 mm) wrist action handle (B-WH4)
- 1/2" NPSM male shank
- 1/4" NPT union tailpiece
- 4-1/8" (105 mm) center of faucet to center of spout
- Spout 15/16" (24 mm) above deck
- 10° angle on aerator
- B-0199-02 aerator (2.2 GPM)
- Metering cartridge conserves water



**B-0831-WA  
Wrist Action Metering Faucet**

- Centerset mixing faucet
- Wrist action metering cartridges with 4" (102 mm) wrist action handles (B-WH4)
- 1/2" NPSM male shanks
- Wrist action handle activation
- Spout 1-1/2" (38 mm) above deck
- B-0199-03 aerator (2.2 GPM)
- Metering cartridges conserve water

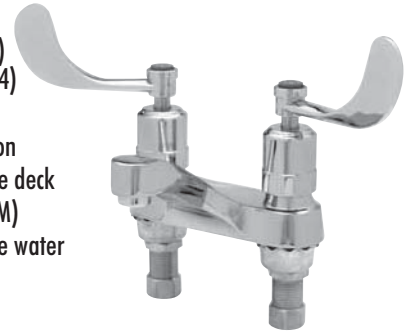

**B-0892-WA  
Wrist Action Metering Faucet**

- Centerset mixing faucet
- Wrist action metering cartridges with 4" (102 mm) wrist action handles (B-WH4)
- 6-5/8" (168 mm) clearance from deck to aerator
- 1/2" NPSM male shanks with coupling nuts
- Rigid gooseneck with 2-3/4" (70 mm) spread (005028-40)
- B-0199-01 aerator outlet (2.2 GPM)
- Metering cartridges conserve water

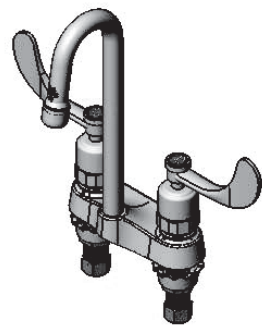

**B-2865-04-WA  
Wrist Action Metering Faucet**

**Easy Install**

- EasyInstall concealed widespread faucet with 8" (203 mm) centers
- Wrist action metering cartridges with 4" (102 mm) wrist action handles (B-WH4)
- 5-1/2" (140 mm) spread rigid gooseneck (000398-40)
- B-0103 rosespray outlet
- 5" (127 mm) clearance from deck to face of spray
- Metering cartridges conserve water

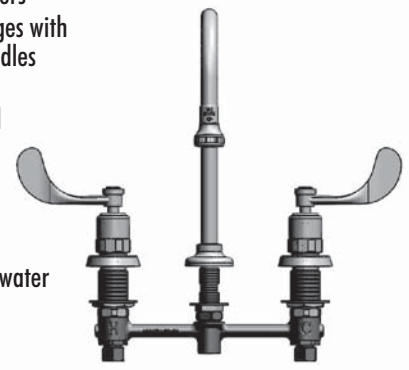

**B-2866-05-WA  
Wrist Action Metering Faucet**

**Easy Install**

- EasyInstall concealed widespread faucet with 8" (203 mm) centers
- Wrist action metering cartridges with 4" (102 mm) wrist action handles (B-WH4)
- 5-3/4" (146 mm) spread swivel gooseneck
- Swivel/rigid gooseneck spout
- B-0199-01 aerator outlet (2.2 GPM)
- 6-1/8" (155 mm) clearance from deck to face of spray
- Metering cartridges conserve water

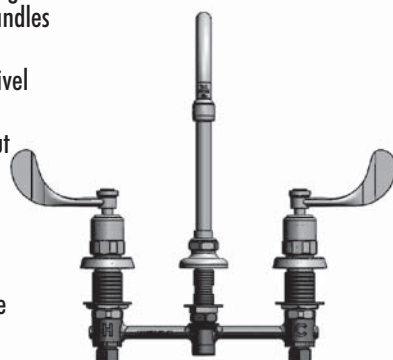

**B-2991-WA  
Wrist Action Metering Faucet**

**Easy Install**

- EasyInstall concealed widespread faucet with 8" (203 mm) centers
- Lavatory spout with B-0199-03 aerator outlet (2.2 GPM)
- Wrist action metering cartridges with 4" (102 mm) wrist action handles (B-WH4)
- Slow-self-closing metering cartridges
- 5-1/4" (134 mm) cast basin spout
- 8" (203 mm) centers
- 2" (51 mm) clearance from deck to aerator
- 1/2" NPSM coupling nuts on inlets
- Metering cartridges conserve water



**Surgical Sink Faucets**

- 8" (203 mm) centers with adjustable inlets

- B-WH4 4" wrist action handles

**B-0322-04  
Surgical Sink Faucet**

- 5-1/2" (140 mm) spread rigid gooseneck (120X)
- 8" (203 mm) centers
- Rosespray outlet (B-0103)
- 7-11/16" (195 mm) clearance from deck to rosespray outlet
- 4" (102 mm) wrist action handles (B-WH4)
- 1/2" NPT female eccentric flanged inlets (00AA)



**B-0322** Same as B-0322-04 except with 6" (152 mm) wrist action handles (B-WH6)  
**B-0323-04** Same as B-0322-04 except with stream regulator outlet (B-LT)  
**B-0324-04** Same as B-0322-04 except with 4" (102 mm) centers and stream regulator outlet (B-LT)

**B-0330-04  
Surgical Sink Faucet**

- 5-1/2" (140 mm) spread rigid gooseneck (120X)
- 8" (203 mm) centers
- Stream regulator outlet (B-LT)
- 4" (102 mm) wrist action handles (B-WH4)
- 1/2" NPT female eccentric flanged inlets (00AA)
- 6" (152 mm) clearance to stream regulator outlet



**B-0350-04** Same as B-0330-04 except with rosespray outlet (B-0103)  
**B-0350** Same as B-0350-04 except with 6" (152 mm) wrist action handles

**B-0352-04  
Surgical Sink Faucet with Built-In Stops**

- 5-1/2" (140 mm) spread rigid gooseneck (120X)
- 8" (203 mm) centers
- Rosespray outlet (B-0103)
- 5-3/8" (137 mm) clearance to sprayface
- 4" (102 mm) wrist action handles (B-WH4)
- Built-in screwdriver stops
- 1/2" NPT female eccentric flanged inlets (00AA)



**B-0353-04** Same as B-0322-04 except with stream regulator outlet (B-LT)  
**B-0352** Same as B-0352-04 except with 6" (152 mm) wrist action handles (B-WH6)

**B-0355-04  
Surgical Sink Faucet with Adjustable Inlet and Loose Key Stops**

- 5-1/2" (140 mm) spread rigid gooseneck (120X)
- Adjustable inlets 3-3/4" (95 mm) to 12-3/4" (319 mm)
- Rosespray outlet (B-0103)
- 4" (102 mm) wrist action handles (B-WH4)
- 1/2" NPT female eccentric flanged inlets with screwdriver stop (00XX)
- 5-3/8" (137 mm) clearance to rosespray outlet



## Pedal Valves

Note: Pedal valves with metering cartridges recommended for use with higher water pressures or when hammer arrestors are not used.

- All models have:
- Self closing valve
  - 1/2" NPT inlet and outlet
  - Extended pedals (wall mounted models)
  - Pedals flip up and stay up for cleaning (wall mounted models)

### B-0502 Double Pedal Valve, Floor Mounted

- Inlets on 2-1/2" (64 mm) centers
- 1" (25 mm) from floor to center of inlets
- 1/2" NPT female inlets and outlets
- Furnished with two wood mounting screws

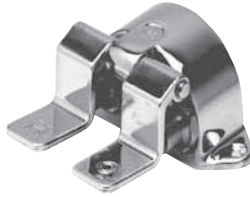

**B-0502-LKS** Same as B-0502 except with loose key stops  
**B-0502-SL** Same as B-0502 except with metering cartridges

### B-0504-01 Double Pedal Valve, Wall Mounted

- Inlets on 2-1/2" (64 mm) centers
- 1" (25 mm) from floor to center of inlets
- Wall to pedal tips approximately 13-3/4" (349 mm)
- Angle loose key stops (B-1350)
- Top mounted volume control angle loose key stop (B-1355)
- 1/2" NPT female inlets and outlets

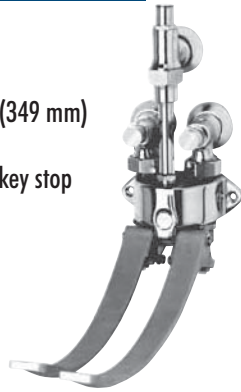

**B-0504-02** Same as B-0504-01 except with volume control straight loose key stop (B-0416)

### B-0507 Single Pedal Valve, Floor Mounted

- For hot or cold water
- 1" (25 mm) from floor to center of inlets
- 1/2" NPT female inlet and outlet
- Furnished with two wood mounting screws



**B-0507-02** Same as B-0507 except with check valve

### B-0508-01 Single Pedal Valve, Wall Mounted

- For hot or cold water
- 1" (25 mm) from wall to center of inlet
- Wall to pedal tip approximately 13-3/4" (349 mm)
- Angle loose key stop on inlet (B-1350)
- Loose key volume control valve with 3/8" IPS female outlet (B-1355)
- 1/2" NPT female inlet and outlet

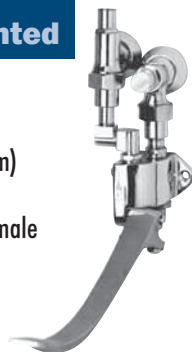

### B-0504 Double Pedal Valve, Wall Mounted

- Inlets on 2-1/2" (64 mm) centers
- 1" (25 mm) from wall to center of outlets
- Wall to pedal tips approximately 13-3/4" (349 mm)
- 1/2" NPT female inlets and outlets
- Furnished with two wood mounting screws



**B-0504-LKS** Same as B-0504 except with straight loose key stops  
**B-0504-SL** Same as B-0504 except with metering cartridges  
**B-0504-03** Same as B-0504 except with loose key angle stops  
**B-0504-03SL** Same as B-0504-03 except with metering cartridges

### B-0505 Double Pedal Valve, Ledge Mounted

- Inlets on 2-1/2" (64 mm) centers
- Rough chrome plated
- 1/2" NPT female inlets and outlets
- Furnished with two wood mounting screws



**B-0505-SL** Same as B-0505 except with metering cartridges

### B-0508 Single Pedal Valve, Wall Mounted

- For hot or cold water
- 1" (25 mm) from wall to center of inlet
- Wall to pedal tip approximately 13-3/4" (349 mm)
- 1/2" NPT female inlet and outlet



**B-0508-LKS** Same as B-0508 except with straight loose key stop; see page D28

### B-2464 Single Pedal Valve & Rigid Gooseneck Spout

- Includes the B-0507 single pedal valve and B-0520 rigid gooseneck spout and rosespray outlet



## Pedal Valves

- All models have:
- Self closing valve
  - 1/2" NPT inlet and outlet
  - Extended pedals (wall mounted models)
  - Pedals flip up and stay up for cleaning (wall mounted models)

### B-0508-02 Single Pedal Valve, Wall Mounted

- For hot or cold water
- 1" (25 mm) from wall to center of inlet
- Wall to pedal tip approximately 13-3/4" (349 mm)
- Angle loose key stop on inlet (B-1350)
- Volume control straight loose key stop (B-0416)



### B-0508-LKS Single Pedal Valve, Wall Mounted

- For hot or cold water
- 1" (25 mm) from wall to center of inlet
- Wall to pedal tip approximately 13-3/4" (349 mm)
- Straight loose key stop on inlet



## Knee Valves

- All models:
- Feed water automatically
  - Provide sensitive, variable flow control for water conservation

### B-0473 Wall Support for Knee Action Valve

- All aluminum, fastens to wall and supports valve body of knee action valve
- Approximately 12" (305 mm) from wall to valve body mounting holes
- 3-1/4" (83 mm) of knee stirrup extends in front of 20" (508 mm) back to front basin
- Can be shortened by cutting aluminum pipe
- Available in longer lengths up to 24" as a special order



### B-0474 Wall Support for Knee Action Valve

- Cast aluminum
- Approximately 11-1/2" (292 mm) from wall to front
- For installation where knee action valve cannot be fastened to horizontal sink support bar
- Bracket supports inlet pipes



### B-0473 Wall Bracket with B-0475 Knee Valve

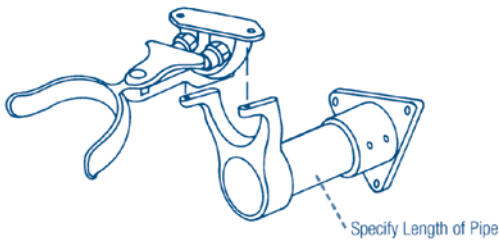

### B-0474 Wall Bracket with B-0475 Knee Valve

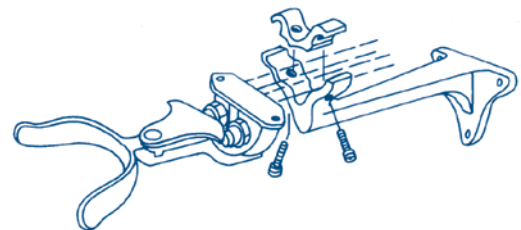

### B-0475 Knee Action Valve

- Heavy duty cam acting stirrup
- Valve will remain in set position for hot, cold or mixed water
- 1/2" NPT female inlets
- 2-1/2" (64 mm) centers
- 1/2" NPT female outlet



**B-0475-LKS** Same as B-0475 except with 1/2" NPT straight loose key stops

### B-0509 Double Knee Pedal Valve

- Inlets on 2-1/2" (64 mm) centers
- Approximately 24" (610 mm) from floor to base of valve
- Pedals 6-1/4" (159 mm) long



## Dummy Goosenecks

### B-0520 and B-0520-F1 Series Rigid Gooseneck Spout

- Deck mounted
- 5-1/2" (140 mm) rigid spread gooseneck (120X)
- B-LT stream regulator outlet
- 10-1/4" (260 mm) high from deck to top of gooseneck
- 5-1/8" (130 mm) clearance from deck to stream regulator outlet



Note: If stream regulator with flow control is desired, refer to the chart below and add the suffix numbers to indicate flow control. For ex.: B-0520-F03 (flow control of .25 GPM)

#### Stream Regulator Flow Control Options:

Flow (GPM)	Suffix
.25	-F03
.40	-F05
.70	-F07
.90	-F10
1.20	-F12
1.40	-F15
2.0	-F20

#### Plain End/Laminar Flow Control Options:

Flow (GPM)	Suffix
.25	-F1-F03
.40	-F1-F05
.70	-F1-F07
.90	-F1-F10
1.20	-F1-F12
1.40	-F1-F15
2.0	-F1-F20

Note: if a plain end (laminar) with flow control is desired, refer to the chart, right, and add the suffix numbers to indicate a plain end spout (-F1) with flow control. For ex.: B-0520-F1-03, (flow control of .25 GPM)

**B-0520-01** Same as B-0520 except with 5-1/4" (133 mm) overall height and 1-3/4" (44 mm) clearance

**B-0521** Same as B-0520 except with aerator (B-0199-02) and 4-3/4" (121 mm) clearance from deck to aerator

**B-0522** Same as B-0520 except with B-0103 rosespray with 4-7/16" (113 mm) clearance from deck to aerator

**B-0523** Same as B-0521 except with 122X gooseneck, 12-1/4" (311 mm) high from deck to top of gooseneck and 6-3/4" (171 mm) clearance from deck to aerator (B-0199-02)

**B-0524** Same as B-0522 except with 122X gooseneck, 12-1/4" (311 mm) high from deck to top of gooseneck and 6-7/16" (113 mm) clearance from deck to rosespray (B-0103)

**B-0546** Same as B-0545 except with swivel spout 5-13/16" (147 mm) clearance from deck to plain end outlet, 5-11/16" (144 mm) spread and 10" (254 mm) overall height

### B-0525 Swivel Goosenecks and Swing Spouts

- 3/8" NPT female inlet
- 5-3/4" (146 mm) spread swivel gooseneck (133X)
- 9-1/16" (230 mm) to top of gooseneck
- B-PT stream regulator outlet
- 5-1/16" (129 mm) clearance from center of inlet to stream regulator



#### Swivel Goosenecks:

**B-0527** Same as B-0525 except with B-0199-01 aerator

**B-0528** Same as B-0525 except with B-0103-01 rosespray outlet

#### Swing Spouts:

**B-0526-2** Same as B-0525 except with 6" (152 mm) swing nozzle (059X)

**B-0526-3** Same as B-0525 except with 8" (203 mm) swing nozzle (060X)

**B-0526-4** Same as B-0525 except with 10" (254 mm) swing nozzle (061X)

**B-0526-5** Same as B-0525 except with 12" (305 mm) swing nozzle (062X)

### B-0529 Swivel Gooseneck Spout

- 3/8" NPT female inlet
- 2-3/4" (70 mm) spread swivel gooseneck
- B-0199-01 aerator (2.2 GPM)
- 4-3/4" (121 mm) to top of gooseneck
- 2-1/4" (57 mm) clearance from center of inlet to aerator



### B-0529-01 Swivel Gooseneck Spout

- Wall mounted
- 3/8" NPT female inlet
- 9-5/16" high swivel gooseneck (132X) with 2-5/8" (67 mm) spread
- B-LT stream regulator
- 5-13/16" (148 mm) clearance from center line of inlet to outlet of stream regulator
- 2-5/8" (67 mm) spread



Find other "Outlet" options, including water-saving outlets for these goosenecks on pages D72-73

## Dummy Goosenecks

### B-0535 Rigid Gooseneck Spout

- Wall mounted
- 3/8" NPT female inlet
- 5-9/16" (141 mm) rigid spread gooseneck (120X)
- 10-5/8" (270 mm) to top of gooseneck
- Rosespray outlet (B-0103)
- 5" (127 mm) clearance from center line of inlet to outlet of rosespray
- 7-9/16" (192 mm) from wall to outlet of rosespray
- 2" (51 mm) flange diameter



### B-0536 Rigid Gooseneck Spout

- 1/2" NPT female inlet
- 11-3/8" (267 mm) to top of gooseneck
- 5-3/4" (146 mm) clearance from center of inlet to rosespray
- 5-1/2" (140 mm) rigid gooseneck (120X)
- Rosespray outlet (B-0103)



## Bubblers

### B-2360 Bubbler



- Flexible mouth guard
- Fast self-closing cartridge with lever handle
- Hidden flow control
- 1/2" NPSM shank and coupling nut



### B-2360-01-PA Bubbler with Pivot Action Metering Valve

- Flexible mouth guard
- Hidden flow control
- 1/2" NPSM shank and coupling nut



Antimicrobial Handles Available

- B-2360-02** Same as B-2360 except with removable anti-rotation pins and forged brass mouth guard
- B-2360-03** Same as B-2360 except with forged brass mouth guard and push-button metering cartridge and removable anti-rotation pins
- B-2360-04** Same as B-2360-02 except with 3" x 4" backing plate
- B-2360-01-AR** Same as B-2360 except with push button metering handle and anti-rotation pins
- B-2360-AR** Same as B-2360 except with anti-rotation pins

### B-2360-01 Bubbler

- Flexible mouth guard
- Push-button metering cartridge
- Hidden flow control
- 1/2" NPSM shank and coupling nut
- Threaded holes on bottom flange accept anti-rotation pins







## Service Sink Faucets

- Built-in screwdriver stops (on select models) allow water shut-off for maintenance on faucet, ie.: removal and replacing Eterna cartridges
- Internal spring checks (on select models) prevent crossflow and back flow of water

### B-0491-01 Service Sink Faucet with Elevated Vacuum Breaker

- 5' elevated atmospheric vacuum breaker
- 6" service sink spout with garden hose thread outlet
- Furnished with top spout brace and (2) B-0110 wall brackets
- 1/2" NPT female flanged adjustable inlets with screwdriver stop (00XX)

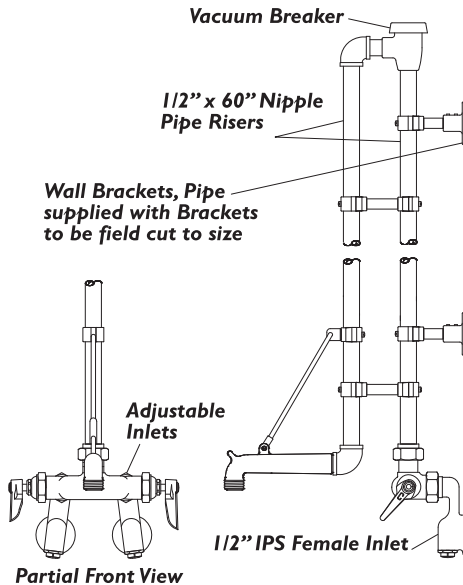

### B-0492-01 Service Sink Faucet with Elevated Vacuum Breaker

- Single temperature supply stop
- 5' elevated atmospheric vacuum breaker
- 6" service sink spout with garden hose thread outlet
- Furnished with top spout brace and (2) B-0110 wall brackets

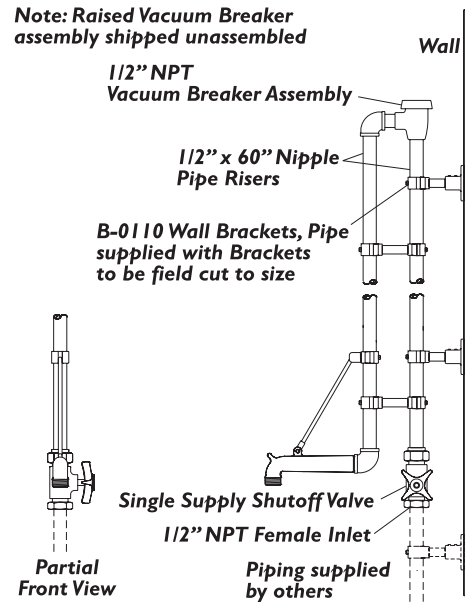

### B-0650-BSTP Service Sink Faucet

- Built in screwdriver stops
- 8" (203 mm) centers
- 5-1/4" (133 mm) clearance wall to center line of faucet
- 12-1/4" (311 mm) from wall to center of outlet
- Polished chrome plated finish
- Bottom support wall brace
- 1/2" NPT female eccentric flanged inlets (00AA)

**B-0650-01** Same as B-0650-POL except with 6" wrist-action handles (B-WH6) and 00XX flanges, adjustable on a 2-1/2" radius, 9-5/16" (237 mm) from wall to center of outlet

**B-0650-BSTR** Same as B-0650-BSTP except with rough chrome plated finish

**B-0650-POL** Same as B-0650-BSTP except without built-in stops

**B-0650-RGH** Same as B-0650-BSTR except without built-in stops

**B-0650-02** Same as B-0650-01 except 15-3/4" (400 mm) from wall to center of outlet



## Service Sink Faucets

### B-0651-POL Service Sink Faucet

- 8" (203 mm) centers
- 5-1/4" (133 mm) clearance from wall to center line of faucet
- 12" (305 mm) from wall to center of outlet
- Polished chrome plated finish
- Bottom support wall brace
- Pail hook
- Plain end spout
- 1/2" NPT female inlets with loose key stops (00JJ-XT)

**B-0651-06** Same as B-0651-POL except with 6" wrist-action handles (B-WH6)  
**B-0362** Same as B-0651-06 except with 3/4" garden hose threads and 15" (375 mm) from center of wall to outlet  
**B-0651-RGH** Same as B-0651-06 except with rough chrome plated finish



### B-0655-01 Service Sink Faucet

- 1/2" NPT female flanged adjustable inlet with screwdriver stops (00XX)
- Inlets adjustable on a 2-1/2" radius
- 6" wrist-action handles (B-WH6)
- Vacuum breaker nozzle with 3/4" garden hose thread and pail hook
- Bottom support and wall brace

**B-0655-02** Same as B-0655-01 except 15-3/4" (400 mm) from wall to center of outlet  
**B-0652** Same as B-0655-02 except without garden hose threads and without vacuum breaker



### B-0655-BSTP Service Sink Faucet

- Built-in screwdriver stops
- 8" (203 mm) centers adjustable from 7-3/4" (197 mm) to 8-1/4" (210 mm)
- 5-1/8" (130 mm) clearance from wall to center line of faucet
- 11-5/8" (295 mm) from wall to center of outlet
- Polished chrome plated finish
- Vacuum breaker nozzle with 3/4" garden hose thread and pail hook
- Bottom support wall brace
- Inlet extensions 5-1/8" from wall to center of faucet

**B-0655-BSTR** Same as B-0655-BSTP except with rough chrome plated finish  
**B-0655-POL** Same as B-0655-BSTP except without built in stops  
**B-0655-RGH** Same as B-0655-BSTR except without built in stops  
**B-0656-POL** Same as B-0655-BSTP except with integral stops (inlets not eccentric)  
**B-0656-RGH** Same as B-0655-BSTR except with integral stops (inlets not eccentric)



## Service Sink Faucets

### B-0657 Service Sink Faucet

- 8" (203 mm) centers
- 5-1/8" (130 mm) clearance from wall to center line of faucet
- 11-5/8" (295 mm) from wall to center of outlet
- Polished chrome plated finish
- Vacuum breaker nozzle with 3/4" garden hose thread and pail hook
- 1/2" NPT female inlet with loose key stops (OOJJ)
- B-WH6 6" (152 mm) wrist-action handles
- Bottom support wall brace
- 1/2" NPT female inlets

**B-0657-01** Same as B-0657 except with top yolk style brace

**B-0657-BST** Same as B-0657 except without OOJJ stops.  
Includes built in stops in body of faucet



### B-0660-POL Service Sink Faucet

- 8" (203 mm) centers adjustable from 7-3/4" (197 mm) to 8-1/4" (210 mm)
- 9" (229 mm) from back of inlets to center of outlet
- Polished chrome plated finish
- Top support wall brace
- 2-3/8" (60 mm) from wall to center line of faucet
- 1/2" NPT female eccentric flanged inlets (OOAA)

**B-0660-BSTP** Same as B-0660-POL except with built-in stops

**B-0660-BSTR** Same as B-0660-BSTP except with rough chrome plated finish

**B-0660-RGH** Same as B-0660-POL except with rough chrome plated finish

**B-0661-POL** Same as B-0660-POL except with OOJJ stops 10" (254 mm) from wall to center of outlet

**B-0661-RGH** Same as B-0661-POL except with rough chrome plated finish



### B-0662 Service Sink Faucet with Ceiling Supply

- Polished chrome plated finish
- 8" (203 mm) centers
- OOJJ stops
- Wall brace assembly
- Lever faucet handles
- Vacuum breaker
- Wall braces designed for exposed ceiling supplies
- May be factory adjusted for floor supplies when specified

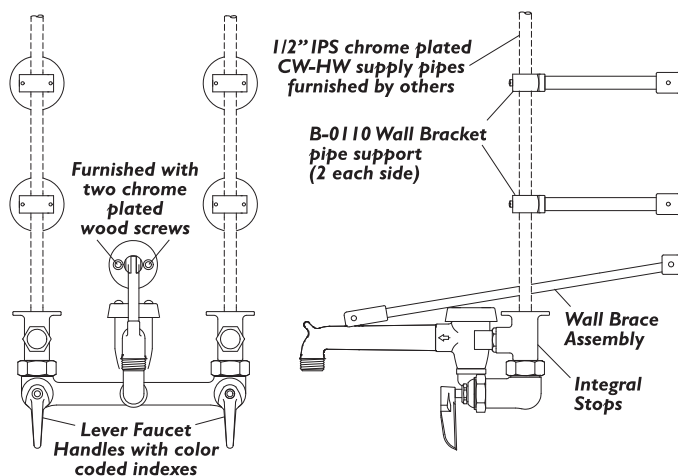

**NEW MODELS!**

## Service Sink Faucets

- Built-in screwdriver stops (on select models) allow water shut-off for maintenance on faucet, ie.: removal and replacing Eterna cartridges
- Internal spring checks (on select models) prevent crossflow and back flow of water

### **B-0664** Service Sink Faucet

- Polished chrome plated finish
- B-WH6 6" wrist action handles
- 1/2" NPT female inlet with loose key stops (00JJ)
- 8" (203 mm) centers
- 9-1/2" (241 mm) from wall to center of outlet
- 3-3/8" (86 mm) from wall to center of faucet
- Bottom wall support
- 3/4" garden hose threads and pail hook

**B-0664-01** Same as B-0664 except with plain end spout, and 15" (381 mm) from wall to outlet and 8-7/8" (225 mm) from wall to center of faucet

**B-0664-02** Same as B-0664 except with plain end spout, and 11-1/4" (286 mm) from wall to outlet and 5-1/8" (130 mm) from wall to center of faucet



### **B-0665-BSTP** Service Sink Faucet

- Built in screwdriver stops
- 8" (203 mm) centers adjustable from 7-3/4" (197 mm) to 8-1/4" (210 mm)
- 2-3/8" (60 mm) clearance from wall to center line of faucet
- 8-7/8" (225 mm) from wall to center of outlet
- Polished chrome plated finish
- Vacuum breaker nozzle with 3/4" garden hose thread and pail hook
- Top support wall brace
- 1/2" NPT female inlet
- Includes spring checks

**B-0658** Same as B-0665-BSTP except with 00JJ stops, 9-7/8" (251 mm) from wall to center of outlet and B-WH6 6" (152 mm) wrist-action handles

**B-0665-BSTP-963** Same as B-0665-BSTP except with B-0963 vacuum breaker

**B-0665-BSTP-CVB** Same as B-0665-BSTP except with continuous vacuum breaker

**B-0665-BSTPM** B-0665-BSTP Master Box (6)

**B-0665-BSTPM24** B-0665-BSTP Master Box (24)

**B-0665-BSTR** Same as B-0665-BSTP except with rough chrome plated finish

**B-0665-BSTR-963** Same as B-0665-BSTR except with B-0963 vacuum breaker

**B-0665-BSTR-CVB** Same as B-0665-BSTR except with continuous vacuum breaker

**B-0665-BSTRM** B-0665-BSTR Master Box (6)

**B-0665-BSTRM12** B-0665-BSTR Master Box (12)

**B-0665-CR-BSTR** Same as B-0665-BSTR except with ceramic cartridges

**B-0665-POL** Same as B-0665-BSTP except without built-in stops

**B-0665-RGH** Same as B-0665-BSTR except without built-in stops

**B-0666-POL** Same as B-0665-POL except with integral stops 9-7/8" (251 mm) from wall to center of outlet, 3-7/8" (86 mm) from wall to center line of faucet

**B-0666-RGH** Same as B-0665-RGH except with integral stops 9-7/8" (251 mm) from back of inlets to center of outlet, 3-7/8" (86 mm) from wall to center line of faucet

**B-1958** Same as B-0658 except 11-5/8" (295 mm) from wall to center of outlet, 4-arm handles (175F)



## Service Sink Faucets

- Built-in screwdriver stops (on select models) allow water shut-off for maintenance on faucet, i.e.: removal and replacing Eterna cartridges
- Internal spring checks (on select models) prevent crossflow and back flow of water

### B-0667-POL Service Sink Faucet

- 1/2" NPT female flanged adjustable inlets with screwdriver stops (OOXX)
- Adjustable centers from 2-1/4" (57 mm) to 8-1/4" (210 mm)
- 9-1/2" (241 mm) from back of inlets to center of outlet
- Polished chrome plated finish
- Atmospheric vacuum breaker nozzle with 3/4" garden hose thread and pail hook
- Top support wall brace
- Includes spring checks



**B-0667-POLM** B-0667-POL Master Box (6)

**B-0667-RGH** Same as B-0667-POL except with rough chrome plated finish

**B-0667-RGHM** B-0667-RGH Master Box (6)

**B-0667-RGHM24** B-0667-RGH Master Box (24)

**B-0668-POL** Same as B-0667-POL except without integral stops in adjustable inlets

**B-0668-RGH** Same as B-0667-RGH except without integral stops in adjustable inlets

### B-0669-POL Service Sink Faucet

- 1/2" NPT female flanged adjustable inlets with screwdriver stops (OOXX)
- Adjustable centers from 2-1/4" (57 mm) to 8-1/4" (210 mm)
- 5-1/2" (140 mm) from back of inlets to center of outlet
- Polished chrome plated finish
- Atmospheric vacuum breaker nozzle with 3/4" garden hose thread
- Includes spring checks



**B-0669-01** Same as B-0669-POL except with B-0673 spout

**B-0669-RGH** Same as B-0669-POL except with rough chrome plated finish

**B-0670-POL** Same as B-0669-POL except without integral stops in adjustable inlets

**B-0670-01** Same as B-0670-POL except with B-0673 spout

**B-0670-RGH** Same as B-0669-RGH except without integral stops in adjustable inlets

### B-0671-POL Service Sink Outlet

- 6-1/8" (156 mm) from back of inlets to center of outlet
- Polished chrome plated finish
- Nozzle has 3/4" garden hose thread and pail hook
- Top support wall brace
- 1/2" NPT female inlet



**B-0671-RGH** Same as B-0671-POL except with rough chrome plated finish

### B-0672-POL Service Sink Faucet

- 8" (203 mm) centers adjustable from 7-3/4" (197 mm) to 8-1/4" (210 mm)
- 4-5/16" (110 mm) from back of inlets to center of outlet
- Polished chrome plated finish
- Plain end spout with pail hook
- 1/2" NPT female eccentric flanged inlets (OAAA)



**B-0672-RGH** Same as B-0672-POL except with rough chrome plated finish

**B-0673-POL** Same as B-0672-POL except with 3/4" garden hose thread on nozzle

**B-0673-RGH** Same as B-0672-RGH except with 3/4" garden hose thread on nozzle

**NEW MODELS!**

## Service Sink and Sill Faucets

- Built-in screwdriver stops (on select models) allow water shut-off for maintenance on faucet, ie.: removal and replacing Eterna cartridges
- Internal spring checks (on select models) prevent crossflow and back flow of water

### B-0674-BSTP Service Sink Faucet

- 8" (203 mm) centers adjustable from 7-3/4" (197 mm) to 8-1/4" (210 mm)
- 4-3/4" (121 mm) from wall to center of outlet
- Polished chrome plated finish
- Vacuum breaker nozzle with pail hook and 3/4" garden hose thread
- 1/2" NPT female eccentric flanged inlets (OOAA)
- Includes spring checks



- B-0674-BSTPM** B-0674-BSTP Master Box (6)
- B-0674-BSTR** Same as B-0674-BSTP except with rough chrome plated finish
- B-0674-BSTRM** B-0674-BSTR Master Box (6)
- B-0674-CR-POL** Same as B-0674-POL except with ceramic cartridges
- B-0674-POL** Same as B-0674-BSTP except without built-in stops
- B-0659** Same as B-0674-POL except with 6" wrist-action handles (B-WH6)
- B-0674-POLM** B-0674-POL Master Box (6)
- B-0674-RGH** Same as B-0674-POL except with rough chrome plated finish
- B-0674-RGHM** B-0674-RGH Master Box (6)
- B-0674-RGHM24** B-0674-RGH Master Box (24)
- B-0693-POL** Same as B-0674-POL except with garden hose outlet and 00JJ inlets with integral stops
- B-2271** Same as B-0674-BSTP except with 3/4"-11 1/2" male garden hose outlet w/ quick-disconnect fitting, rough chrome finish
- B-2271-CR** Same as B-2271 except with cerama cartridges with check valves

### B-0692 Service Sink Outlet

- Concealed loose key valve with 1/2" NPT female inlet (B-0127)
- Nozzle with 3/4" garden hose thread outlet
- Elevated vacuum breaker (B-0929-A)



### B-0695-ST Service Sink Fitting

- Concealed bypass mixing valve on 8" (203 mm) centers
- 1/2" NPT pipe outlet
- Roughing 2-1/2" (64 mm) minimum to 3-1/2" (89 mm) maximum center of inlets to finished wall face
- Top braced nozzle with 3/4" garden hose thread and pail hook
- Elevated vacuum breaker (B-0929-A)
- Loose key valves behind teardrop flanged outlets with 1/2" NPT female inlets and outlets

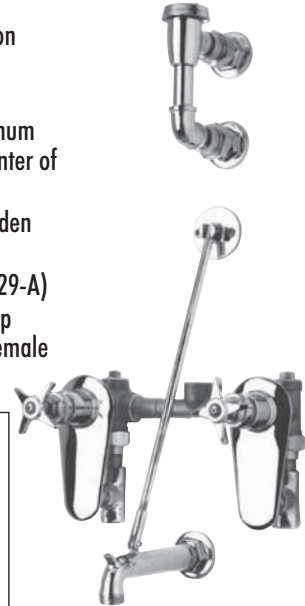

- B-0695** Same as B-0695-ST except without integral stops, includes standard flanges and with B-0969 vacuum breaker; includes loose key stops behind flanges

### B-0697 Service Sink Fitting

- Concealed mixing valve with 1/2" NPT union inlet
- 8" (203 mm) centers
- Roughing 2-1/2" (64 mm) minimum to 3-3/4" (95 mm) maximum center of inlets to finished wall face
- Braced nozzle with 3/4" garden hose thread and pail hook
- 1/2" NPT female inlet

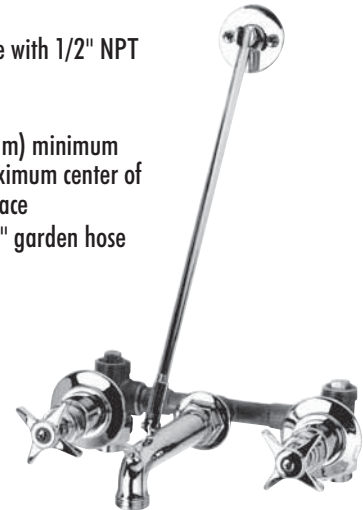

- B-0698** Same as B-0697 except with solder type union inlets for 5/8" (16 mm) O.D. copper tubing
- B-0699** Same as B-0697 except with vacuum breaker nozzle
- B-0699-ST** Same as B-0699 except with integral stops and teardrop flanges

### Service Sink Faucets

#### B-2480 Service Sink Faucet

- 1/2" NPT female inlets
- Rough chrome plated finish
- 8" (203 mm) centers adjustable from 7-3/4" (197 mm) to 8-1/4" (210 mm)
- 2-3/8" (60 mm) from wall to center of faucet
- 4-5/16" (110 mm) from wall to center of outlet
- 3/4" garden hose outlet and pail hook
- Four-arm handles (175F)



### Sill and Heavy Duty Sink Faucets

#### B-0700 Single Sink Faucet

- 1/2" NPT female inlet
- 3-7/8" (98 mm) from outlet to center of spout
- Four-arm handle (175F)

**B-0700-LT-CR-K** Same as B-0700 except with B-LT outlet, ceramic cartridge and inlet installation kit  
**B-0702** Same as B-0700 except with 3/4" garden hose outlet



#### B-0703 Single Sink Faucet

- 1/2" NPT male inlet
- 3-1/2" (89 mm) wall to center of spout
- Four-arm handle (175F)

**B-0704** Same as B-0703 except with 3/4" garden hose outlet



#### B-0706 Self-Closing, Single Sink Faucet

- 1/2" NPT female inlet
- 3-7/8" (98 mm) wall to center of spout
- Four-arm handle (061L)
- Quick self-closing valve

**B-0707** Same as B-0706 except with 3/4" garden hose outlet



### Accessories

#### B-0618-01 Reinforced PVC Hose

- Reinforced PVC hose
- 3' (914 m) long
- 3/4" garden hose inlet
- Plain outlet



**B-0618-02** Same as B-0618-01 except with 4' (1.2 m) hose  
**B-0618-03** Same as B-0618-01 except with 5' (1.5 m) hose

#### B-0653 Mop Hanger



- Stainless steel mop hanger
- Three spring-loaded rubber grips
- 24" (610 mm) long x 3-3/4" (95 mm) wide

#### B-0654 Stainless Steel Hose Bracket

- Stainless steel hose bracket
- Spring-loaded rubber grip
- 3' (914 mm) rubber hose (B-0618-01) with 3/4" garden hose inlet



#### B-0708 Self-closing, Single Sink Faucet

- 1/2" NPT male inlet
- 3-1/2" (89 mm) wall to center of spout
- Four-arm handle (061L)
- Quick self-closing valve

**B-0709** Same as B-0708 except with 3/4" garden hose outlet  
**B-0709-JJ** Same as B-0709 except with JJ union coupling inlet with loose key stop



## Sill and Heavy Duty Sink Faucets

### B-0710 Single Basin Faucet

- 1/2" NPS male shank
- 4-1/8" (105 mm) from center of faucet to center of spout
- Four-arm handle (175F)
- B-0109-01 aerator
- 10° angle on aerator



**B-0710-01** Same as B-0710 except with alpine handle (076F)

**B-0710-WS** Same as B-0710 except with low-flow aerator (1.5 GPM)

**B-0711** Same as B-0710 except with quick self-closing valve, four arm handle (061L)

New  
Water-Saving  
Model

### B-0717 Single Sink Faucet

- 1/2" NPT male inlet
- Adjustable flange
- 5" (127 mm) from inlet to center of outlet
- Lever handle (177F)
- 3/4" garden hose outlet



**B-0718** Same as B-0717 except with four arm handle (175F)

### B-0730 Sill Faucet

- 1/2" NPT female flanged inlet
- Key (001802-45) or screwdriver controlled handle
- 3/4" garden hose outlet
- Rough chrome plated finish



**B-0730-POL** Same as B-0730 except with polished chrome plated finish

**B-0731-POL** Same as B-0730-POL except with 3/4" female inlet

### B-2460 Single Basin Faucet

- 1/2" NPS male shank
- 4-1/8" (105 mm) from center of faucet to center of spout
- 4" wrist-action ceramic cartridge assembly
- Anti-rotation cover plate
- 10° angle on aerator



### B-0715 Single Sink Faucet

- 1/2" NPT male inlet
- Adjustable flange
- 6" (152 mm) inlet to center of outlet
- Lever handle (177F)
- Plain outlet



**B-0716** Same as B-0715 except with four arm handle (175F)

### B-0720 Sill Faucet with Vacuum Breaker

- 1/2" NPT female flanged inlet
- Key (001802-45) or screwdriver controlled handle
- Atmospheric vacuum breaker
- 3/4" garden hose outlet
- Polished chrome plated finish



**B-0720-RGH** Same as B-0720 except with rough chrome plated finish

**B-2301** Same as B-0720 except with four arm handle (175F)

### B-0736-POL Sill Faucet with Vacuum Breaker

- 1/2" NPT female flanged inlet
- Loose key included (001802-45) or screwdriver controlled handle
- Removable vacuum breaker
- 3/4" garden hose outlet
- Polished chrome plated finish



**B-0736** Same as B-0736-POL except with rough chrome finish

**B-0737** Same as B-0736-POL except with 3/4" female inlet and rough chrome finish

**B-0737-POL** Same as B-0736-POL except with 3/4" female inlet



## Bedpan Washers

### B-0675 Bedpan Washer

- Pedal valve (B-0504-01) with 1/2" NPT female inlets with integral loose key angle stops (B-1350)
- Volume control valve (B-1355) with 3/8" NPT female outlet on pedal valve
- Vacuum breaker (B-0929) with 3/8" NPT flanged inlet
- Wall hook hose connection with 3/8" NPT flanged inlet
- 5' (1.5 m) PVC hose (B-0068-R) with self closing valve (002865-40)

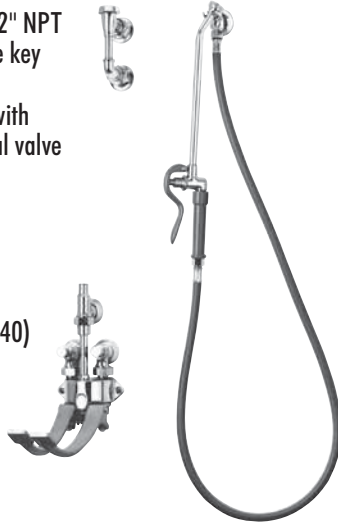

**B-0676** Same as B-0675 except with extended spray connected directly to hose – self closing valve is omitted

**B-0676-54V** Same as B-0676 except with 54" (1372 mm) vinyl hose

### B-0678 Bedpan Washer

- 1/2" NPT female loose key angle inlet valve with shut-off and vacuum breaker (B-0968) outlet
- 5' (1.5 m) PVC hose (B-0068-R) with self closing valve (002865-40)



**B-0679** Same as B-0678 except with extended spray connected directly to hose – self closing valve is omitted

### B-0687 Bedpan Washer

- Single pedal valve (B-0508-01) with 1/2" NPT female inlet with integral stops (B-1350)
- Volume control valve (B-1355) with 3/8" NPT female outlet on pedal valve
- Vacuum breaker has 3/8" NPT female flanged inlet and outlet
- 5' (1.5 m) PVC hose (B-0068-R) with self closing valve (002861-40)



### B-0677 Bedpan Washer

- Pedal valve (B-0504-01) with 1/2" NPT female inlets with integral stops (B-1350)
- Volume control valve (B-1355) with 3/8" NPT female outlet on pedal valve
- Vacuum breaker unit has 3/8" NPT female flanged inlet and outlet
- 5' (1.5 m) PVC hose (B-0068-R) with extended spray outlet (002861-40)



### B-0685 Bedpan Washer

- Single pedal valve (B-0508-01) with 1/2" NPT female inlet with integral stops (B-1350)
- Volume control valve (B-1355) with 3/8" NPT female outlet on pedal valve
- Vacuum breaker (B-0929) with 3/8" NPT inlet and outlet on 3-3/4" (95 mm) centers
- Wall hook hose connection with 3/8" NPT female flanged inlet
- 5' (1.5 m) PVC hose (B-0068-R) with self closing valve (002865-40)



**B-0686** Same as B-0685 except with extended spray connected directly to hose – self closing valve is omitted

## Bedpan Washers

### B-0680-ST Bedpan Washer

- Concealed bypass mixing valve (B-1035-ST) with 1/2" NPT female union inlets on 8" (203 mm) centers
- Integral straight loose key stops (B-0416)
- Vacuum breaker (B-0929-A) with 1/2" NPT female connection on 3-3/4" (95 mm) centers
- Wall hook hose connection with 3/8" NPT female flanged inlet
- 5' (1.5 m) PVC hose (B-0068-R) with self closing spray valve (002865-40)

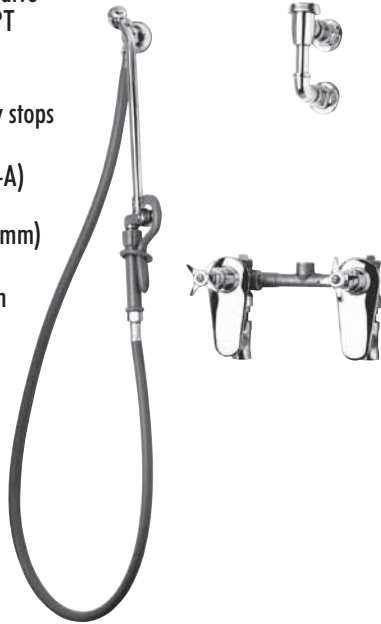

### B-0104 Wall Hook Outlet

- 3/8" NPT flanged female inlet
- All brass, chromium plated
- 3/4" - 14 male outlet



### B-0682-ST Bedpan Washer

- Concealed bypass mixing valve (B-1035-ST) with 1/2" NPT female union inlets on 8" (203 mm) centers
- Integral straight loose key stops (B-0416)
- Front mount vacuum breaker outlet
- 5' (1.5 m) PVC hose (B-0068-R) with self closing spray valve (002865-40)
- Wall hook (B-0104-D)



**B-0682** Same as B-0682-ST except without loose key stops

### B-0104-D Dummy Wall Hook

- Attaches to wall with screws provided
- Flange diameter 2" (51 mm)



## Bedpan Washers, Hoses and Sprays

### B-0690 Bedpan Washer with Self Closing Spray Valve

- 1/2" NPT male inlet adapter (055A)
- 5' (1.5 m) reinforced PVC hose (B-0068-R)
- Self closing spray valve (002865-40)



### B-0691 Bedpan Washer with Extended Spray Outlet

- 1/2" NPT male inlet adapter (055A)
- 5' (1.5 m) reinforced PVC hose (B-0068-R)
- Extended spray outlet (002861-40)



Bedpan Washers, Hoses and Sprays

**B-0950**  
Bedpan Washer with Self-Closing Valve

- 1/2" NPT male inlet adapter (055A)
- 4' (1.2 m) stainless steel hose (B-0044-H)
- Angle self-closing spray outlet (002853-40)



**B-0956** Same as B-0950 except with 3' (914 mm) reinforced PVC hose

**B-0955**  
Bedpan Washer with Self-Closing Valve

- 1/2" NPT male inlet adapter (055A)
- 4' (1.2 m) reinforced PVC hose (B-0044-R)
- Self-closing spray valve (B-0107)



**B-0957** Same as B-0955 except with 3' (914 mm) braided vinyl hose

**B-0973**  
Bedpan Washer with Self-Closing Valve

- 1/2" NPT male inlet adapter (055A)
- Stainless steel hose (B-0056-H)
- Push button self-closing spray valve with adjustable spray angle head



**B-0974**  
Bedpan Washer with Self-Closing Valve

- 1/2" NPT male inlet adapter (055A)
- Stainless steel hose (B-0056-H)
- Self-closing spray valve with adjustable spray angle head



Notes

**Concealed Single Valves**

**B-1020  
Concealed Bypass Valve**

- 1/2" NPT female inlet and outlet
- Four arm handle – "Cold"
- Adjustable wall flange

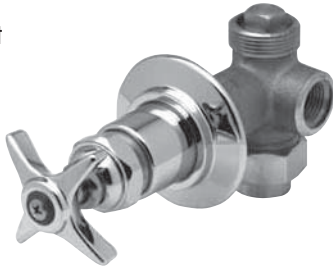

**B-1025-ST  
Concealed Straight Valve**

- 1/2" NPT inlet and outlet
- Integral stop
- Tear drop flange



**B-1027-UCP  
Concealed Straight Loose Key Stop**

- 1/2" NPT female inlet and outlet

**B-1027** Same as B-1027-UCP except without a union coupling nut  
**B-1028** Same as B-1027 except with built-in check valve feature



**B-1025  
Concealed Straight Valve**

- 1/2" NPT female inlet and outlet
- Four arm handle – "Cold"
- Adjustable wall flange



**B-1025-1** Same as B-1025 except with "Hot" handle  
**B-1026-1** Same as B-1025 except with clear alpine handle (001144-45) "Hot"

**B-1029-PA  
Concealed Straight Valve**

**NEW!**

- Straight pivot action metering valve
- 1/2" NPT female inlet and outlet
- Vandal resistant
- Blank index



**B-1029  
Concealed Straight Valve**

- Straight slow self-closing valve
- 1/2" NPT female inlet and outlet
- Vandal resistant
- Blank index



**B-1029-1** Same as B-1029 except indexed "Cold"  
**B-1029-2** Same as B-1029 except indexed "Hot"

**Concealed Bypass Mixing Valves**

**B-1035  
Concealed Bypass Mixing Valve**

- 8" (203 mm) centers
- 1/2" NPT female union inlets
- 1/2" NPT female bottom outlet
- Four arm handles (175F)

**B-1035-ST** Same as B-1035 except with loose key handle integral stops

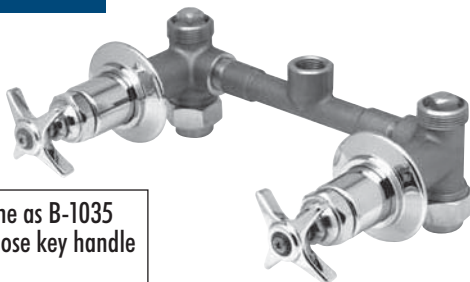

## Accessories

### B-0900 Spray Assembly

- 3' (.9 m) stainless steel spray assembly
- 2-3/4" (70 mm) diameter rubber bumper
- 1/2" NPT male adapter furnished on inlet



### B-1091 Deluxe Shower Head

**NEW FEATURES!**

- 2.2 GPM @ 60 PSI / 2.5 GPM @ 80 PSI flow rate
- 1/2" NPT inlet
- Adjustable wall flange
- Solid brass construction
- Brass ball swivel joint and shank
- Spray adjusting peanut handle
- 2-3/4" face
- 6 Lexan deposit-resisting plungers with 48 spray channels
- Pressure-compensating limiter precisely control jets and channels transforming any water pressure into forceful, fully adjustable spray
- Transition from needling full-body to rinsing gentle rain to drenching full-flood sprays



### B-1095 Bath Tub Spout

- Chrome plated finish
- 3/4" NPT female inlet
- Furnished with twin el flow diverter



### B-1090 Shower Head

- 2.2 GPM @ 60 PSI / 2.5 GPM @ 80 PSI flow rate
- Adjustable spray shower head
- 1/2" NPT male arm
- Adjustable wall flange
- Ball joint head



### B-1092 Vandal Resistant Shower Head

- 2.2 GPM @ 60 PSI / 2.5 GPM @ 80 PSI flow rate
- Wall mounted vandal resistant shower head
- 1/2" NPT back inlet



### B-1097 Two-Way Diverter Valve

- Used to divert flow between shower and hand spray
- 1/2" NPT female connections
- Lever handle (177F)



## Notes

**NEW! Pressure Balancing Shower Valve, Assemblies and Parts**



**B-3200 Series  
Pressure Balancing Shower Valve,  
Shower Head and Tub Spout**

- Solid brass pressure balancing shower valve with replaceable cartridge
- Integral supply stops
- Temperature limit stop
- 2.5 GPM polished chrome shower head with ball joint, arm and wall flange assembly
- Polished chrome rotary handle
- Polished chrome faceplate with screws and gasket
- Solid brass tub spout with diverter lift knob in polished chrome plated finish
- ASSE 1016 Listed
- Sweat connections



**B-3200 Series Parts and Accessories:**

<b>017439-45</b>	Solid brass tub spout with diverter lift knob, polished chrome finish
<b>017441-45</b>	Ceramic cartridge, rotary actuation with adjustable temperature limit stop
<b>017442-45</b>	Polished chrome shower head with ball joint, arm and wall flange assembly
<b>017443-45</b>	Polished chrome rotary handle
<b>017444-45</b>	Polished chrome face plate with screws and gasket

**B-3201  
Pressure Balancing  
Shower Valve Assembly**

- Same as B-3200 except without tub spout
- Sweat connections on shower valve



**B-3204  
Pressure Balancing  
Shower Valve**

- Pressure balancing shower valve with trim plate and handle
- Sweat connections on shower valve



**B-3204-PBV  
Pressure Balancing  
Shower Valve**

- Pressure balancing shower valve
- Sweat connections on shower valve



**B-3206  
Pressure Balancing Shower Valve  
Assembly**

- Includes B-3201 pressure balancing shower valve assembly without tub spout, B-1097 diverter valve and B-0925 Shower Queen spray assembly with grab bar
- Sweat connections on shower valve

**B-3205  
Pressure Balancing Shower  
Valve Assembly**

- Includes pressure balancing shower valve and hand held spray assembly with flow control (thumb valve adjusts flow from 0.5 GPM to 2.0 GPM)
- Sweat connections on shower valve



**B-3206-VB  
Pressure Balancing Shower Valve Assembly**

- Same as the B-3206 and includes a B-0970-01 wall-mounted vacuum breaker attached to Shower Queen spray hose assembly
- Sweat connections on shower valve

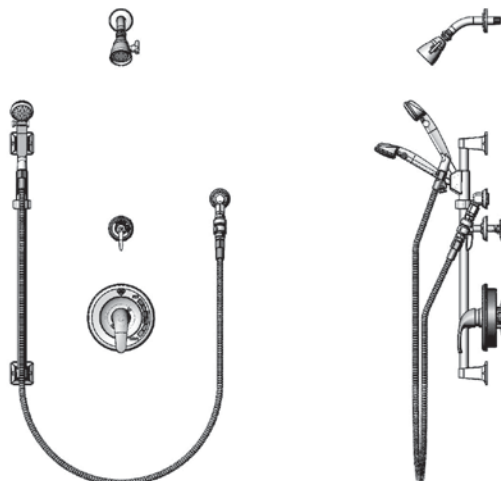



**NEW! Pressure Balancing Shower Valve with Threaded Connections**

**B-3300 Series  
Pressure Balancing Shower Valve, Shower Head  
and Tub Spout with Threaded Connections**

- Solid brass pressure balancing shower valve with replaceable cartridge
- **NEW!** Threaded connections for easy installation
- Integral supply stops
- Temperature limit stop
- 2.5 GPM polished chrome shower head with ball joint, arm and wall flange assembly
- Polished chrome rotary handle
- Polished chrome faceplate with screws and gasket
- Solid brass tub spout with diverter lift knob in polished chrome plated finish
- ASSE 1016 Listed

**NEW  
Models  
Threaded  
Connections**



**B-3300 Series Parts and Accessories:**

<b>017439-45</b>	Solid brass tub spout with diverter lift knob, polished chrome finish
<b>017441-45</b>	Ceramic cartridge, rotary actuation with adjustable temperature limit stop
<b>017442-45</b>	Polished chrome shower head with ball joint, arm and wall flange assembly
<b>017443-45</b>	Polished chrome rotary handle
<b>017444-45</b>	Polished chrome face plate with screws and gasket

**B-3305  
Pressure Balancing Shower  
Valve Assembly**

- Includes pressure balancing shower valve and hand held spray assembly with flow control (thumb valve adjusts flow from 0.5 GPM to 2.0 GPM)
- Threaded connections on valve



**B-3301  
Pressure Balancing Shower  
Valve Assembly**

- Same as B-3200 except without tub spout
- Threaded connections on shower valve



**B-3304  
Pressure Balancing  
Shower Valve**

- Pressure balancing shower valve with trim plate and handle
- Threaded connections on shower valve



**B-3304-PBV  
Pressure Balancing  
Shower Valve**

- Pressure balancing shower valve
- Threaded connections on shower valve



**B-3306  
Pressure Balancing Shower Valve  
Assembly**

- Includes B-3301 pressure balancing shower valve assembly without tub spout, B-1097 diverter valve and B-0925 Shower Queen spray assembly with grab bar
- Threaded connections on shower valve

**B-3306-VB  
Pressure Balancing Shower Valve Assembly**

- Same as the B-3306 and includes a B-0970-01 wall-mounted vacuum breaker attached to Shower Queen spray hose assembly
- Threaded connections on shower valve

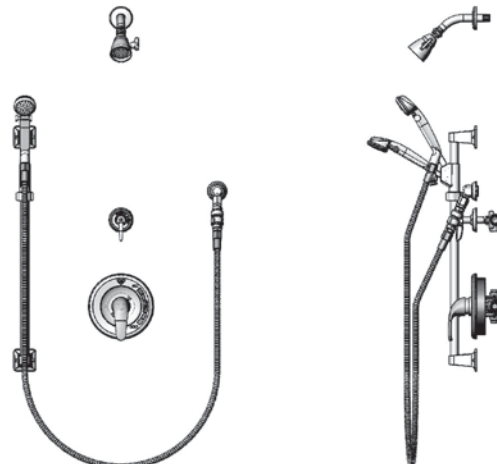

### Bath and Shower Combinations

#### **B-0933-ST** Patient's Bath Fitting with Flexible Personal Spray

- Concealed bypass mixing valve (B-1035-ST) with 1/2" NPT female union inlets on 8" (203 mm) centers
- Integral straight loose key stops (B-0416) with built-in check valves
- Vacuum breaker (B-0929-A) with 1/2" NPT female connection on 3-3/4" (95 mm) centers
- B-0926 personal spray with 1/2" NPT flanges female wall connection
- B-0940 grab bar with adjustable holder
- 60" (1524 mm) flexible hose (013E-60) with hand spray (SQ-0095)
- Throttle down thumb valve on spray assembly switches flow between 2.0 GPM and 0.5 GPM



Notes

### "Shower Queen" Flexible Personal Spray Assemblies

#### **B-0921** Shower Queen Assembly with Diverter Valve

- Chrome plated diverter valve
- 1/2" NPT female thread connects to existing shower arm and shower head
- Wall spray bracket (SQ-0092)
- Hand held spray (SQ-0095)
- 5 ft. (1.5 m) stainless steel hose (013E-60)
- Shower head not included
- Throttle down thumb valve on spray assembly switches flow between 2.0 GPM and 0.5 GPM

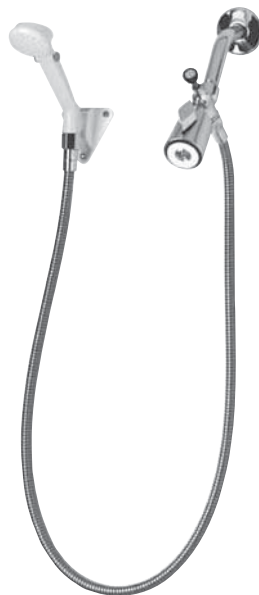

#### **B-0925** Shower Queen Assembly with Grab Bar

- Wall outlet with 3/8" NPT flanged female inlet
- 5 ft. (1.5 mm) stainless steel hose (013E-60)
- B-0940 grab bar 24" (610 mm) long
- Sliding spray bracket
- Throttle down thumb valve on spray assembly switches flow between 2.0 GPM and 0.5 GPM



**B-0926** Same as B-0925 except with wall outlet with 1/2" NPT flanged female inlet



“Shower Queen” Flexible Personal Spray Assemblies



**B-0930**  
Shower Queen Assembly

- Wall outlet with 1/2" NPT female inlet
- 5 ft. (1.5 mm) stainless steel hose (013E-60)
- Wall bracket to hold spray head at two angles
- Atmospheric vacuum breaker
- Throttle down thumb valve on spray assembly switches flow between 2.0 GPM and 0.5 GPM

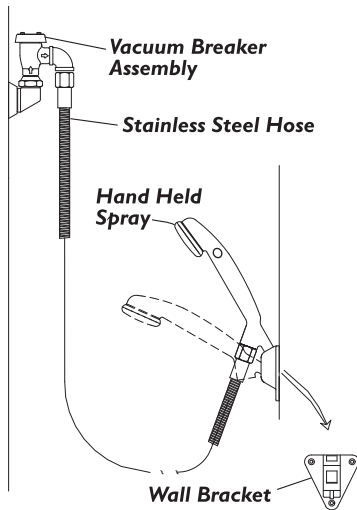

**B-0937**  
Shower Queen Assembly

- 1/2" NPT male inlet
- 60" (1.5 mm) stainless steel hose (013E-60)
- Hand held spray (SQ-0095)
- Throttle down thumb valve on spray assembly switches flow between 2.0 GPM and 0.5 GPM
- Wall spray bracket (SQ-0092)



**B-0938**  
Shower Queen Assembly

- 1/2" NPT male inlet
- 60" (1.5 m) vinyl hose (013E-60V)
- Hand held spray (SQ-0095)
- Throttle down thumb valve on spray assembly switches flow between 2.0 GPM and 0.5 GPM
- Wall spray bracket (SQ-0092)



“Shower Queen” Accessories

**B-0940**  
Vertical Grab Bar with Sliding Spray Bracket

- 24" (610 mm) long vertical grab bar
- Sliding spray bracket



**SQ-0092**  
Wall Spray Bracket

- Mounts to wall
- Holds personal spray
- Two position sockets

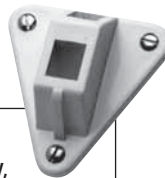

Also available:  
**SQ-0093** Wall outlet assembly, 3/8" NPT inlet  
**SQ-0093-LF** Wall outlet less flange, 3/8" NPT inlet  
**SQ-0094** Wall outlet assembly with male adapter  
**SQ-0099** Sliding spray bracket

**SQ-0100**  
Diverter Valve

- 1/2" NPT female inlet
- 1/2" NPT male outlet
- Diverts water to hand held spray by pulling knob
- Mounts on existing shower arm before shower head



**SQ-0095**  
Shower Queen Hand Spray

**NEW DESIGN!**

- Hand spray with adjusting thumb valve button to throttle down water flow, from 2.0 GPM to 0.5 GPM



## Vacuum Breaker Assemblies

### B-0455 Vacuum Breaker Assembly

- 6" (152 mm) C/C mounting vacuum breaker unit
- 1/2" NPT

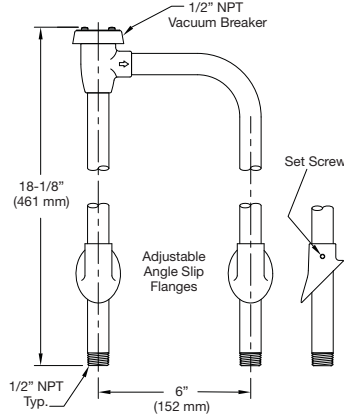

### B-0455-04 Vacuum Breaker Assembly

- 4" (102 mm) C/C mounting vacuum breaker unit
- 1/2" NPT
- Adjustable angle slip flanges
- Factory pre-assembled

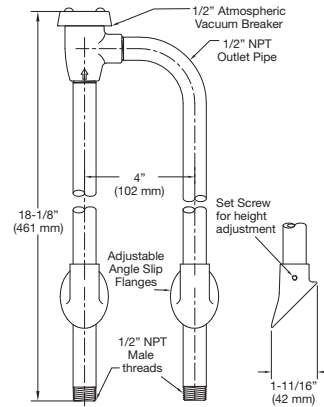

### B-0456 Vacuum Breaker Assembly

- 6" (152 mm) C/C mounting vacuum breaker unit
- 1/2" NPT
- Adjustable flanges
- Pipes must be held rigid under sink with connection fitting, brace, etc.

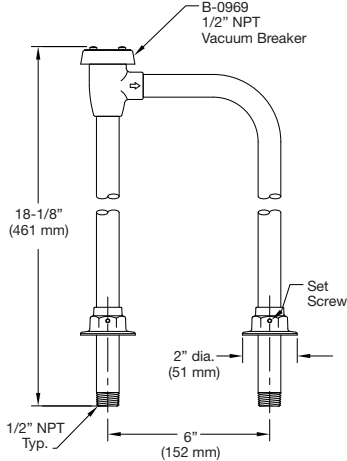

### B-0456-04 Vacuum Breaker Assembly

- 4" (102 mm) C/C mounting vacuum breaker unit
- 1/2" NPT
- Adjustable flanges
- Factory pre-assembled

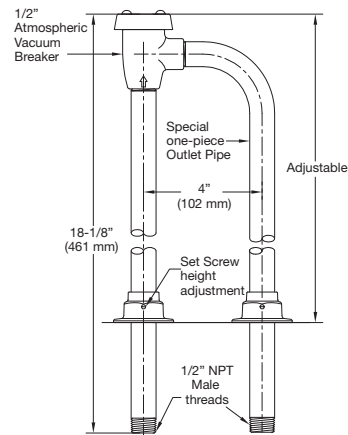

D  
50

### B-0457 Vacuum Breaker Assembly

- 8" (203 mm) C/C mounting vacuum breaker unit
- 3/4" NPT
- Pipes must be held rigid under sink with connection fitting, brace, etc.

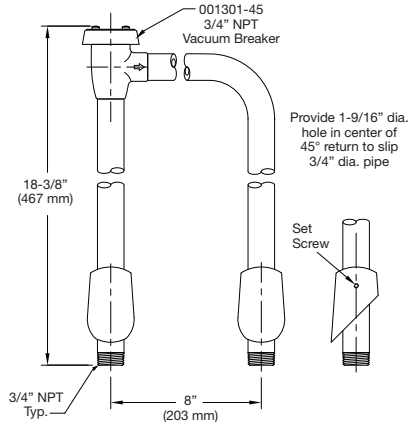

### B-0458 Vacuum Breaker Assembly

- 8" (102 mm) C/C mounting vacuum breaker unit
- 3/4" NPT
- Adjustable angle slip flanges
- Pipes must be held rigid under sink with connection fitting, brace, etc.

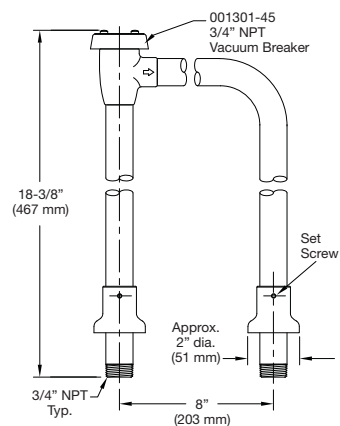

## Lab Hose Cocks and Turrets

### BL-4000-01 Hose Cock

- CSA approved
- 3/8" NPT male inlet
- Serrated hose tip
- Snap-in color index; specify gas, air or vacuum
- Length 3-3/16" (81 mm); height 2-1/2" (63 mm)



Note: **should not** be used for water, steam or oxygen

BL-4000-01M Master Box (12)

### BL-4100-0 Laboratory Turret

- Two 3/8" NPT female outlets at 90°
- 3/8" NPT female inlet
- Black plastic mounting gasket included
- 2" (51 mm) diameter; height 2-9/16" (65 mm)
- 2" (51 mm) height to center of outlet



- BL-4100-01 3/8" NPT female bottom inlet; 3/8" NPT female side outlet (1)
- BL-4100-02 Two outlets at 180°
- BL-4100-03 Three outlets
- BL-4100-04 Four outlets
- BL-4100-05 Top outlet only

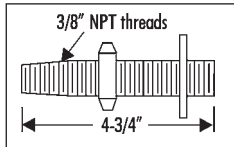

Note: BL-5500-10 supply nipple and locknut ordered separately

### BL-4102-0 Vandal Resistant Lab Turret

- 1/4" diameter stud to prevent rotation
- Black plastic mounting gasket included
- 2" (51 mm) diameter; height 3" (76 mm)
- 2-1/8" (54 mm) height to center of outlet
- 3/8" NPT female inlet
- Two 3/8" NPT female side outlets



- BL-4102-01 3/8" NPT female bottom inlet; 3/8" NPT female side outlet (1)
- BL-4102-02 Two outlets at 180°

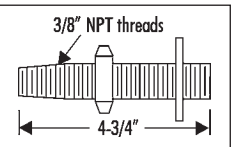

Note: BL-5500-10 supply nipple and locknut ordered separately

### BL-4010-01 Needle Valve

- 3/8" NPT male inlet
- Floating stainless steel needle point
- Serrated hose tip
- For use with oxygen, hydrogen or other special gases
- Length 3-3/16" (81 mm); height 2-15/16" (75 mm)
- 125 PSI maximum pressure

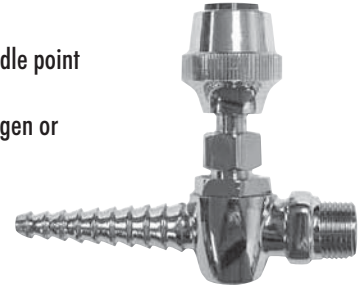

Note: **should not** be used for water or steam

### BL-4200-0 Turret with Two Hose Cocks

- 3/8" NPT female inlet
- Snap-in color coded index; specify gas, air or vacuum
- Diameter 2" (51 mm); height 3-9/16" (90 mm)
- Two hose cocks at 90°
- Not recommended for pressures in excess of 30 PSI



- BL-4200-01 Turret with hose cock
- BL-4200-02 Turret with two hose cocks at 180°
- BL-4200-04 turret with four hose cocks

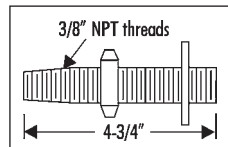

Note: BL-5500-10 supply nipple and locknut ordered separately

### BL-4203-0 Vandal Resistant Turret with Hose Cock

- 1/4" diameter stud to prevent rotation
- 3/8" NPT female bottom inlet
- Two 3/8" NPT hose cocks at 90°
- 2" (51 mm) diameter; 3-11/16" (94 mm) height
- 2-1/8" (54 mm) height to center of outlet
- Snap-in color coded index; specify gas, air or vacuum
- Not recommended for pressures in excess of 30 PSI



- BL-4203-01 3/8" IPS female side outlet (one)
- BL-4203-02 Turret with two hose cocks at 180°
- BL-4203-04 Turret with four hose cocks

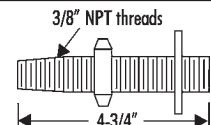

Note: BL-5500-10 supply nipple and locknut ordered separately

Panel Flanges, Hose Cocks and Turrets

**BL-4210-01**  
Turret with Needle Valve

- 3/8" NPT female bottom inlet
- One 3/8" NPT hose cock
- 2" (51 mm) diameter;
- 4-3/8" (111 mm) height
- 2" (51 mm) height to center of outlet
- Valve has floating stainless steel needle point
- For use with oxygen, hydrogen or other special gases



BL-4210-0

**BL-4210-0** Turret with two needle hose cocks at 90° (shown above)  
**BL-4210-02** Turret with two needle hose cocks at 180°

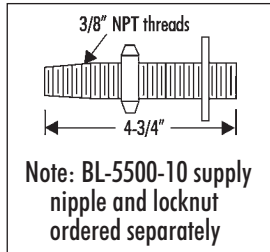

**BL-4250-02**  
Double Panel Flange with Two Hose Cocks

- 3/8" NPT female inlet
- Dual ground key hose cocks with serrated hose tips
- 3-7/8" (98 mm) from wall
- 1-13/16" (46 mm) flange diameter
- 6-1/8" (156 mm) width
- Snap-in color coded index; specify gas air or vacuum
- Not recommended for pressures in excess of 30 PSI

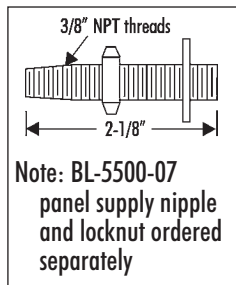
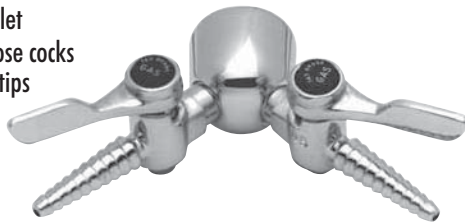

**Inset: BL-4250-05**  
Double panel flange with 3/8" NPT inlet and dual outlets

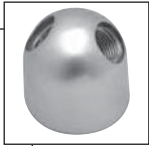

**BL-4250-08**  
Wye Fitting

- 3/8" NPT male inlet
- Two 3/8" NPT female outlets
- 70° angle between outlets



**BL-4250-01**  
Panel Flange with Hose Cock

- 3/8" NPT female inlet
- Ground key hose cock
- Serrated hose tip
- 4-1/2" (114 mm) length
- 2" (51 mm) flange diameter
- Snap-in color coded index; specify gas, air or vacuum
- Not recommended for pressures in excess of 30 PSI

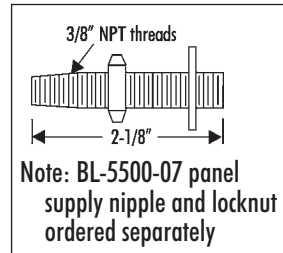
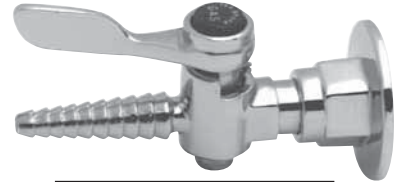

**BL-4250-07**  
Flanged Elbow

- 3/8" IPS female inlet and outlet
- 2" (51 mm) flange diameter
- 2-1/16" (52 mm) from flange surface to center of outlet
- Can be mounted vertically or horizontally



**BL-4260-01**  
Panel Flanges with Needle Valve

- 3/8" NPT female inlet
- Needle valve with serrated hose tip
- 4-1/2" (114 mm) length from wall to tip
- 2" (51 mm) diameter flange
- Snap-in color coded index; specify gas, air or vacuum

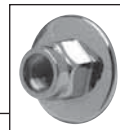
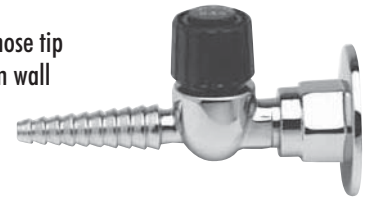

**Inset: BL-4250-03** Panel flange with 3/8" NPT female inlet and outlet  
**BL-4250-04** Same as BL-4250-03 except with 1/2" NPT female inlet and outlet  
**BL-4250-06** Same as BL-4250-03 except with 1/2" NPT female inlet, 3/8" NPT female outlet

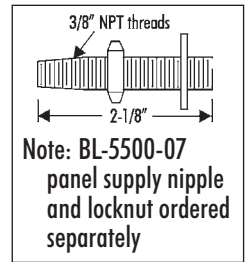

## Panel Flanges, Stops and Turrets

### BL-4300-0 Turret with Two Straight Stops

- Turret with two straight stops (BL-4500-1) at 90°
- 3/8" NPT female inlet
- Serrated hose tips
- 5-1/2" (140 mm) from center of inlet to end of tip
- 5-1/2" (140 mm) height
- 2" (51 mm) diameter turret
- Snap-in color coded index; specify gas, air or vacuum

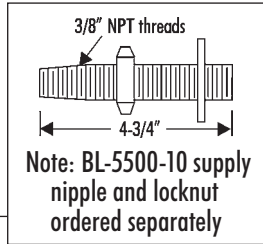

**BL-4300-01** Turret with one straight stop

**BL-4300-02** Turret with two straight stops at 180°

**BL-4300-04** Turret with four stops

### BL-4422-0 Turret with Two Water Outlets

- 2" (51 mm) diameter turret base
- Double water outlet with angle serrated hose tips at 90°
- Atmospheric vacuum breaker
- 3/8" NPT female inlet

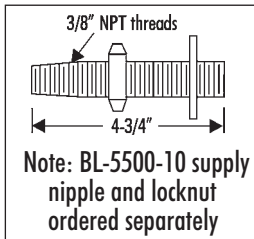

**BL-4422-01** Same as BL-4422-0 except with one water outlet

### BL-4501-01 Straight Stop

- Straight stop for special gases
- 3/8" NPT male inlet
- Internal floating stainless steel cone regulates gas flow as handle is turned
- Serrated hose tip



### BL-4350-01 Panel Flange with Straight Stop

- 3/8" NPT female inlet
- Serrated hose tip
- 5-5/8" (143 mm) length
- 2" (51 mm) diameter flange
- Snap-in color coded index; specify gas, air or vacuum
- Internal floating stainless steel cone regulates gas flow as handle is turned
- Forged brass four arm handle



**BL-4355-01** Same as BL-4350-01 except for water; specify hot or cold

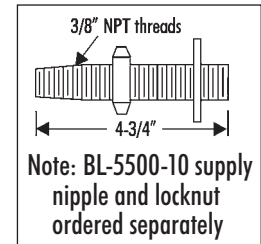

### BL-4500-01 Straight Stops

- 3/8" NPT male inlet
- 5" (127 mm) length
- Removable serrated hose tip
- Forged brass four-arm handle
- Snap-in color coded index; specify gas, air or vacuum
- Internal floating stainless steel cone regulates gas flow as handle is turned

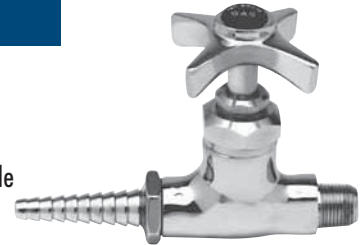

**BL-4500-02** Same as BL-4500-01 except with Eterna construction for water; specify hot or cold

**BL-4500-04** Same as BL-4500-03 except with angle serrated tip

### BL-4520-01 Angle Stop

- 3/8" NPT male inlet
- Serrated hose tip
- Floating stainless steel cone and removable seat
- Forged brass four-arm handle with colored index
- Snap-in color coded index; specify gas, air or vacuum
- 3-1/2" (89 mm) length from center
- 4-5/8" (117 mm) height



Note: 3/8" NPT female or 1/2" NPT male inlet available upon request

**BL-4520-02** Same as BL-4520-01 except Eterna construction for water; specify hot or cold

## Remote Control Valve Units

### BL-4700-01 Remote Control Straight Valve Unit

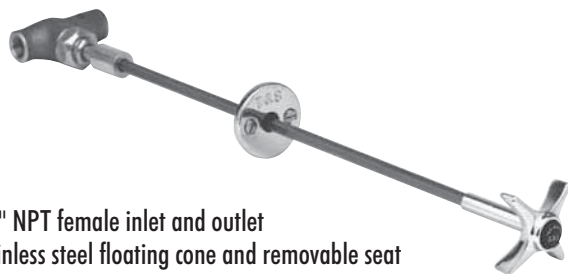

- 3/8" NPT female inlet and outlet
  - Stainless steel floating cone and removable seat
  - Snap-in color coded index; specify gas, air or vacuum
  - Specify distance from center of valve to face of panel – standard is 18" (457 mm)
  - Furnished with polished chrome guide for use on wood furniture
- Note: Valve can be furnished with 3/8" NPT male or 1/2" NPT male inlet when specified

**BL-4700-01MF** Same as BL-4700-01 except with guide bushing for metal furniture  
**BL-4700-02** Same as BL-4700-01 except with Eterna construction for water; specify hot or cold

### BL-4720-01 Remote Control Angle Valve Unit

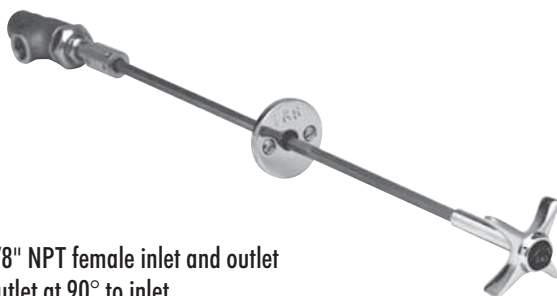

- 3/8" NPT female inlet and outlet
  - Outlet at 90° to inlet
  - Stainless steel floating cone and removable seat
  - Snap-in color coded index; specify gas, air or vacuum
  - Specify distance from center of valve to face of panel – standard is 18" (457 mm)
  - Furnished with polished chrome guide for use on wood furniture
- Note: Valve can be furnished with 3/8" NPT male or 1/2" NPT male inlet when specified

**BL-4720-01MF** Same as BL-4720-01 except with guide bushing for metal furniture  
**BL-4720-02** Same as BL-4720-01 except with Eterna construction for water; specify hot or cold  
**BL-4720-02MF** Same as BL-4720-02 except with guide bushing for metal furniture  
**BL-4720-03** Same as BL-4720-01 except with stainless steel floating cone and seat for steam. With black heat resistant handle

### BL-4710-01 Remote Control Straight Valve Unit



- Universal joint at valve to correct for minor misalignment
  - 3/8" NPT female inlet and outlet
  - Stainless steel floating cone and removable seat
  - Specify gas, air or vacuum
  - Specify distance from center of valve to face of panel – standard is 18" (457 mm)
  - Furnished with polished chrome guide for use on wood furniture
- Note: Valve can be furnished with 3/8" NPT male or 1/2" NPT male inlet when specified

**BL-4710-02** Same as BL-4710-01 except with Eterna construction for water; specify hot or cold  
**BL-4710-03** Same as BL-4710-01 except with stainless steel floating cone and seat for steam. With black heat resistant handle

### BL-4730-03 Remote Control Angle Valve Unit



- Universal joint at valve to correct for minor misalignment
  - 3/8" NPT female inlet and outlet
  - Stainless steel floating cone and seat for steam
  - Black heat-resistant handle (not shown)
  - Snap-in color coded index; specify gas, air or vacuum
  - Specify distance from center of valve to face of panel – standard is 18" (457 mm)
  - Furnished with polished chrome guide for use on wood furniture
- Note: Valve can be furnished with 3/8" NPT male or 1/2" NPT male inlet when specified

## Fume Hood Fittings

### BL-4705-01 Front Mounted Fume Hood Valve

- 3/8" NPT female inlet and outlet
- For flat face hood
- Stainless steel cone and removable seat
- Forged brass four-arm handle with colored index
- Snap-in color coded index; specify gas, water or vacuum
- Working parts are removable from front eliminating entry into hood compartments



**BL-4705-02** Same as BL-4705-01 except with Eterna construction for water; specify hot or cold  
**BL-4705-03** Same as BL-4705-01 except with heat resistant handle for steam

### BL-4750-05 Panel Flange with Straight Serrated Tip

- 3/8" NPT female inlet
- 2" (51 mm) diameter flange
- 3-5/8" (92 mm) length



**BL-4750-06** Same as BL-4750-05 except with angle serrated tip, 3-1/2" (89 mm) length

### BL-4750-03 Turret with Rigid Gooseneck

- 3/8" NPT female inlet
- For use with remote valves
- Serrated hose tip
- Plastic mounting gasket included
- 2" (51 mm) diameter
- 11-1/2" (292 mm) height
- 5-1/2" (140 mm) spread gooseneck



**BL-4750-07** Same as BL-4750-03 except with wall mounted turret

### Notes

---

---

---

---

---

---

---

---

---

---

---

---

---

---

---

---

---

---

---

---

---

---

---

---

---

## Front Guide Fittings for Remote Control Valve Units

### BL-4740-03 Angle Guide Bushing

- Polished chrome plated
- For use on wood furniture
- Furnished with two screws
- 2" (51 mm) x 1-7/16" (37 mm)
- 45° angle standard – can be furnished at any angle from 30° to 60° in sufficient quantity
- Mounting holes on 1-9/16" (40 mm) centers



## Support Rods and Accessories

### BL-9000-01 Upright Rod

- 3/4" (19 mm) diameter aluminum rod
- 39" (991 mm) long
- Tapered on one end to fit BL-9000-09 flush plate



### BL-9000-05 Aluminum Cross Bar

- 3/4" diameter aluminum rod
- 39" (991 mm) long

### BL-9000-09 Flush Plate

- 1-1/8" (29 mm) diameter shank
- Fits table tops from 3/4" (19 mm) to 1-1/2" (38 mm) thick
- Fits into recess in table to receive BL-9000-01 upright rods
- Satin chrome plated brass



### BL-9000-10 Clamp

- For 3/4" (19 mm) diameter aluminum rods
- Satin aluminum finish



### BL-9005-01 Crowned Top Flush Plate

- Convex top surface for use on tabletops without recess
- 1-1/8" (29 mm) diameter thread
- Fits table tops from 3/4" (19 mm) to 1-1/2" (38 mm) thick
- Designed to receive BL-9000-01 upright rods
- Satin chrome plated brass



## Double Ledge Faucets

### BL-5700-01 Double Ledge Faucet

- Single hole base with under counter spreader assembly
- 1/2" NPT male inlets
- 3/8" NPSM gooseneck, 5-1/2" (140 mm) spread
- 1-1/8" (25 mm) shank diameter
- 13-11/16" (347 mm) height
- Plastic mounting gasket included
- Serrated hose tip
- Tailpiece and nut furnished for optional 1/4" NPT connection



**BL-5700-02** Same as BL-5700-01 except with swivel gooseneck, 13-5/8" (346 mm) height

**BL-5700-03** Same as BL-5700-01 except with swivel gooseneck with swivel to rigid conversion washer

**BL-5700-04** Same as BL-5700-01 except with B-0199-02 aerator in place of serrated tip

### BL-5700-08 Double Ledge Faucet

- Rigid vacuum breaker gooseneck
- Single hole base with under counter spreader assembly
- 1/2" NPT male inlets
- 3/8" NPSM gooseneck with 5-7/16" (138 mm) spread
- 1-1/8" (29 mm) shank diameter
- 12-3/8" (314 mm) height
- Plastic mounting gasket included
- Serrated hose tip
- Tailpiece and nut furnished for optional 1/4" NPT connection



**BL-5700-08-VR** Same as BL-5700-08 except with vandal-resistant pins

**BL-5700-09** Same as BL-5700-08 except swivels at vacuum breaker



## Double Ledge Faucets

### BL-5704-01 Double Ledge Faucet

- 1/2" NPT male inlets
- Single hole base with under counter spreader assembly
- 3/8" NPSM gooseneck, 5-1/2" (140 mm) spread
- 1-1/8" (25 mm) shank diameter
- 13-11/16" (347 mm) height
- Plastic mounting gasket included
- Serrated hose tip
- Tailpiece and nut furnished for optional 1/4" NPT connection



- BL-5704-02** Same as BL-5704-01 except with swivel gooseneck
- BL-5704-03** Same as BL-5704-01 except with swivel gooseneck (5-7/8") spread and swivel to rigid conversion washer
- BL-5704-04** Same as BL-5704-01 except with B-0199-02 aerator in place of serrated tip (2.2 GPM)
- BL-5704-05** Same as BL-5704-04 except with quarter-turn eterna cartridges and 4" (102 mm) wrist action handles except with B-0199-02 aerator in place of serrated tip (2.2 GPM)

### BL-5704-08 Double Ledge Faucet

- Rigid vacuum breaker gooseneck
- 1/2" NPT male inlets
- Single hole base with under counter spreader assembly
- 3/8" NPSM gooseneck with 5-11/16" (144 mm) spread
- 1-1/8" (29 mm) shank diameter
- 12-3/8" (314 mm) height
- Plastic mounting gasket included
- Serrated hose tip
- Tailpiece and nut furnished for optional 1/4" NPT connection



- BL-5704-09** Same as BL-5704-08 except swivels at vacuum breaker
- BL-5704-08WH4** Same as BL-5704-08 except with 4" (102 mm) wrist action handles

## Single Ledge Lab Faucets

### BL-5705-01 Single Ledge Faucet

- Rigid gooseneck
- 1/2" NPSM shank
- 3/8" NPSM gooseneck with 5-5/8" (144 mm) spread
- 14-1/8" (359 mm) height
- Plastic mounting gasket included
- Removable serrated hose tip
- Specify hot or cold
- Fits ledge up to 1-1/2" (28 mm) thick
- Tailpiece and nut furnished for optional 1/4" NPT connection



- BL-5705-02** Same as BL-5705-01 except with swivel gooseneck, height 14-3/16" (360 mm)
- BL-5705-03** Same as BL-5705-01 except with swivel gooseneck with rigid to swivel conversion washer
- BL-5705-04** Same as BL-5705-01 except with B-0199-02 aerator in place of serrated tip

### BL-5705-08 Single Ledge Faucet

- Rigid vacuum breaker gooseneck
- 1/2" NPSM shank
- 3/8" NPSM gooseneck with 5-11/16" (144mm) spread
- 1-1/8" (29 mm) shank diameter
- 12-3/4" (324 mm) height
- Plastic mounting gasket included
- Serrated hose tip
- Specify hot or cold
- Fits ledge up to 1-1/2" (38 mm) thick
- Tailpiece and nut furnished for optional 1/4" NPT connection



- BL-5705-09** Same as BL-5705-08 except with swivel at vacuum breaker
- BL-5705-08-VR** Same as BL-5705-08 except with vandal-resistant anti-rotation screws in base, vandal-resistant handle and vandal-resistant loctited joints

## Lab Faucets

### BL-5710-01 Single Sink Faucet

- 1/2" NPT female inlet
- 3/8" NPSM rigid gooseneck
- 11" (279 mm) height from center of inlet to top of gooseneck
- 5-5/8" (143 mm) gooseneck spread
- 8-1/2" (210 mm) distance from wall to outlet
- Specify hot or cold water
- Serrated hose tip



**BL-5710-03** Same as BL-5710-01 except with swivel gooseneck

**BL-5710-07** Same as BL-5710-01 except with rigid vacuum breaker nozzle, 10-1/16" (256 mm) height from center of inlet to top of vacuum breaker

**BL-5710-09** Same as BL-5710-01 except with swivel vacuum breaker nozzle

**BL-5860-01TL** Same as BL-5710-01 except interior tin-lined for distilled water, with four arm handle

### BL-5715-08 Ledge Mixing Faucet

- Rigid vacuum breaker nozzle
- 1/2" NPT female inlets on 8" (203 mm) centers
- 3/8" NPSM rigid gooseneck
- 11-15/16" (303 mm) height from deck to top of vacuum breaker
- 5-7/16" (138 mm) nozzle spread
- Serrated hose tip



**BL-5715-01** Same as BL-5715-08 except with standard rigid gooseneck (inset, above)

**BL-5715-02** Same as BL-5715-01 except with standard swivel gooseneck

**BL-5715-09** Same as BL-5715-08 except with swivel vacuum breaker nozzle

### BL-5725-08 Sink Mixing Faucet

- Rigid vacuum breaker nozzle
- 1/2" NPT female inlets on 8" (203 mm) centers, wall mount
- 3/8" NPSM gooseneck
- 9-1/2" (241 mm) height from center of inlet to top of gooseneck
- 5-7/16" (138 mm) gooseneck spread
- Serrated hose tip



**Inset: BL-5725-01** Same as BL-5725-08 except with standard rigid gooseneck

**BL-5725-02** Same as BL-5725-01 except with standard swivel gooseneck

**BL-5725-09** Same as BL-5725-08 except with swivel vacuum breaker gooseneck

### BL-5707-01 Single Science Table Faucet

- Vandal resistant single science table faucet
- 1/2" NPSM shank
- 2" (51 mm) diameter on base
- Two brass balls lock into table top indents to prevent vandalizing (drilling template included)
- 13-3/16" (335 mm) height
- 6-1/2" (166 mm) spread nozzle
- 1/2" NPT heavy duty riser pipe
- Serrated hose tip
- Tailpiece and nut furnished for optional 1/4" NPT connection



**BL-5707-04** Same as BL-5707-01 except handle is 180° to nozzle

Lab Faucets

**BL-5707-03  
Combination Science Table Faucet**

- Vandal resistant combination science table faucet
- 1/2" NPSM shank
- 2" (51 mm) diameter on bases
- 12-3/4" (324 mm) height
- Two brass balls lock into table top indents to prevent vandalizing (drilling template included)
- 5-7/16" (138 mm) spread nozzle
- 1/2" NPT heavy duty riser pipe
- Serrated hose tip
- Plastic mounting gasket included
- Specify distance between centers of faucets – standard is 6"
- One hot index, one cold index
- Tailpiece and nut furnished for optional 1/4" NPT connection



**BL-5709-01  
Single Ledge Faucet**

- 1/2" NPT shank
- 3/8" NPSM gooseneck with 5-5/8" (144 mm) spread
- 14-1/8" (359 mm) height
- Specify hot or cold water
- Serrated hose tip
- Plastic mounting gasket included
- Tailpiece and nut furnished for optional 1/4" NPT connection



**BL-5709-02** Same as BL-5709-01 except with swivel gooseneck, height 14-3/16" (360 mm)  
**BL-5709-04** Same as BL-5709-01 except with B-0199-02 aerator in place of serrated tip

**BL-5709-08  
Single Ledge Faucet**

- Rigid vacuum breaker nozzle
- 1/2" NPSM shank
- 3/8" NPSM gooseneck with 5-7/16" (138 mm) spread
- 12-11/16" (322 mm) height
- Serrated hose tip
- Plastic mounting gasket included
- Specify hot or cold water
- Tailpiece and nut furnished for optional 1/4" NPT connection



**BL-5709-09** Same as BL-5709-08 except with swivels at vacuum breaker  
**BL-5709-05** Same as BL-5709-09 except with swivel nozzle with swivel to rigid conversion washer and 4" (102 mm) wrist action handle  
**BL-5709-08WH4** Same as BL-5709-08 except with 4" (102 mm) wrist action handle

**BL-5735-01  
Wall Mounted Mixing Faucet**

- 1/2" NPT female inlets
  - Rigid gooseneck with 5-5/8" (143 mm) spread
  - Four arm handles
  - Serrated hose tip
- Note: 3/4" female inlets and swing nozzle available as modifications

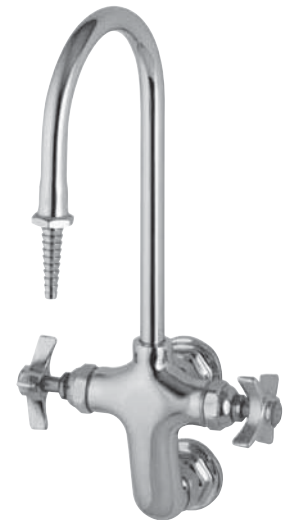

**BL-5735-09** Same as BL-5735-01 except with swivel vacuum breaker gooseneck nozzle  
**BL-5735-02** Same as BL-5735-01 except with swivel gooseneck

Lab Faucets

**BL-5740-01**  
Sink Mixing Faucet

- 1/2" NPT female inlets adjustable from 2-1/4" (57 mm) to 8-1/4" (210 mm) centers
- 3/8" NPSM rigid gooseneck
- 10-1/4" (260 mm) height from center of faucet to top of gooseneck
- 8-1/2" (216 mm) from wall to outlet of gooseneck
- 5-5/8" (144 mm) gooseneck spread
- Serrated hose tip



**BL-5740-02** Same as BL-5740-01 except with swivel gooseneck  
**BL-5740-08** Same as BL-5740-01 except with rigid vacuum breaker nozzle

**BL-5755-01**  
Single Temperature Lab Faucet

- 1/2" NPSM male shank
- Fits ledges up to 1-1/2" (38 mm) thick
- 9" (229 mm) swing nozzle with stream regulator outlet
- Four arm handle
- Tailpiece and nut furnished for optional 1/4" NPT connection



**BL-5750-01**  
Sink Mixing Faucet

- 1/2" NPT male inlet
- 3/8" NPSM gooseneck
- Removable serrated hose tip
- Specify hot or cold water
- Tailpiece and nut furnished for optional 1/4" NPT connection



**BL-5775-08**  
Sink Mixing Faucet

- 1/2" NPT female inlets on 8" (203 mm) centers
- 8-5/8" (219 mm) vacuum breaker swing nozzle
- Serrated hose tip



**BL-5775-01** Same as BL-5775-08 except with standard swing nozzle, no vacuum breaker

**BL-5850-01**  
Single Self-Closing Ledge Faucet

- 1/2" NPT female inlet
- 3/8" NPSM rigid gooseneck
- Fits ledges up to 1-1/2" thick
- Serrated hose tip
- Specify hot or cold water
- Tailpiece and nut furnished for optional 1/4" NPT connection
- 14-1/8" (359 mm) height
- 5-5/8" (181 mm) spread
- Fast self closing four arm handle

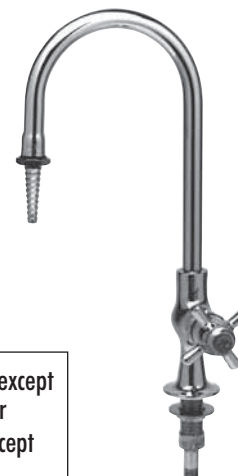

**BL-5850-01TL** Same as BL-5850-01 except interior is tin-lined for distilled water  
**BL-5850-02** Same as BL-5850-01 except with swivel gooseneck

**BL-5800-02**  
Single Supply Lab Faucet

- Serrated hose tip
- Four arm handle
- 1/2" NPT female inlet
- 4" (102 mm) length



Lab Faucets

**BL-6000-02**  
Combination Gas and Water Faucet

- Combination unit with gooseneck and two hose cocks
- 3/8" NPT male inlets for water and gas
- Serrated hose tip
- Specify gas, air or vacuum to snap-in color coded index
- 10-1/2" (267 mm) height
- 6" (152 mm) spread gooseneck
- Four arm handle
- Furnished with two (2) supply nipples, special lock washer, lock nuts and mounting gasket



**BL-6000-03** Same as BL-6000-02 except 15-1/4" (387 mm) height and 8" (203 mm) spread gooseneck

**BL-6005-02**  
Combination Gas and Water Faucet

- Combination unit with rigid vacuum breaker nozzle and two hose cocks
- 3/8" NPT male inlets for water and gas
- Serrated hose tip
- Specify gas, air or vacuum to snap-in color coded index
- 11-1/2" (292 mm) height
- 6" (152 mm) spread gooseneck
- Four arm handle
- Furnished with two (2) supply nipples, special lock washer, lock nuts and mounting gasket



**BL-6005-03** Same as BL-6005-02 except with 8" gooseneck spread

Lab Faucets and Miscellaneous Fixtures

**BL-6050-01**  
Multi-Water Fixture

- 1/2" NPT female inlet
- 3/8" NPSM gooseneck
- 18-3/8" (466 mm) overall height
- 5-5/8" (143 mm) spread rigid gooseneck
- Serrated hose tip
- One bottom valve
- Four arm chrome plated brass handles with colored index buttons

Note: BL-5500-12 supply nipple and lock nut sold separately



**BL-6050-02** Same as BL-6050-01 except with two bottom valves at 180°

**BL-9515-01**  
PVC Single Ledge Faucet Self-Closing

- PVC faucet with rigid gooseneck
- Dual lever control for manual or self-closing operation
- 1-1/4" (32 mm) dia. shank and locknut
- Serrated hose tip
- 3/8" NPT female inlet
- All PVC for use with distilled water
- 12-1/4" (311 mm) height, 6-1/4" (159 mm) spread



**BL-9515-02** Same as BL-9515-01 except no shank and lock nut, with 1/2" NPT female inlet  
**BL-9515-03** Same as BL-9515-01 except self-closing only

**BL-9505-01**  
PVC Single Ledge Faucet  
Compression Type

- PVC faucet with rigid gooseneck
- 1-1/4" (32 mm) diameter threaded shank and locknut
- Serrated hose tip
- 3/8" NPT female inlet
- All PVC for use with distilled water
- 12-1/4" (311 mm) height, 6-1/4" (159 mm) spread



**BL-9505-02** Same as BL-9505-01 except no shank and lock nut, with 1/2" NPT female inlet

**BL-5000-01**  
Double Pedal Valve

- Floor-mounted double pedal valve
- Self-closing valve with two pedals
- 1/2" NPT female inlets and outlet
- 2-1/2" (64 mm) center to center of inlets
- 1" (25 mm) from floor to center of inlets



**BL-5000-02**  
Single Pedal Valve

- Floor-mounted single pedal valve
- Self closing valve with one pedal
- 1/2" NPT female inlet and outlet
- 1" (25 mm) from floor to center of inlet



Lab Accessories

**BL-5500-0**  
Filter Pump (Aspirator)

- 3/8" NPT male inlet
- Includes check valve
- 2-15/16" (75 mm) overall length
- Creates suction by water flow

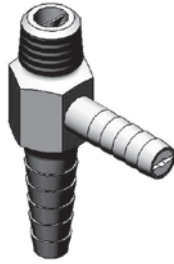

**BL-5500-07**  
Supply Nipple Unit

- Supply nipple and lock nut
- 3/8" NPT threads
- 2-1/8" (54 mm) long
- Used with panel flanges

**BL-5500-09** Same as BL-5500-07 except with 1/2" NPT threads, 2" (51 mm) long for use on panel mount faucets

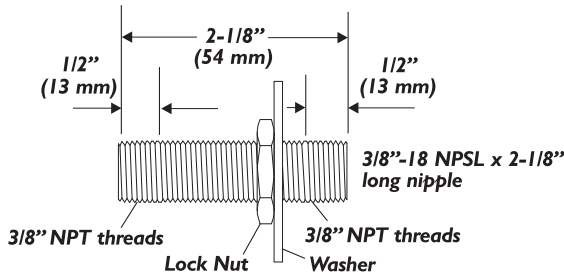

**BL-5500-03**  
6" Wrist Action Handle

- 6" (152 mm) long
- Can be used in place of lever handles originally furnished
- Chrome plated brass
- Includes color coded index button



**BL-5500-10**  
Supply Nipple Unit

- Supply nipple, lock nut and washer
- 3/8" NPT threads
- 4-3/4" (121 mm) long
- For use with BL-4100 turret series

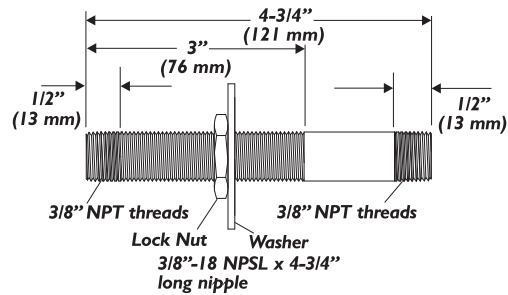

**BL-5500-08** Same as BL-5500-10 except with 1/2" NPT threads, 3-3/8" (86 mm) long; for use on ledge mount faucets

**BL-5505-07**  
Four Arm Handle

- Black polypropylene
- Color coded snap-in index button and screw



**BL-5545-01**  
Volume Control Unit

- Volume control fitting with adjustable volume control knob
- 3/8" NPT inlet and outlet



**BL-5550-01**  
Non-Splash Aerator

- Aerator with 3/8" NPSM male adapter
- Fits lab goosenecks



**BL-5550-01F** Same as BL-5550-01 except with flow control

Lab Accessories

**BL-5550-04**  
Straight Serrated Hose Tip

- 3/8" (9 mm) NPT male inlet
- Serrated hose tip
- 2-5/8" (67 mm) long
- Fits lab goosenecks and nozzles

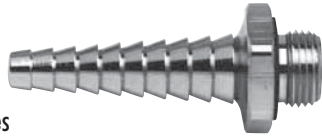

**BL-5550-05** Same as BL-5550-04 except with angle tip

**BL-5550-10**  
Vacuum Breaker

- Garden hose vacuum breaker prevents back siphonage
- 3/4" female garden hose inlet and male outlet
- Used to attach garden hose to unprotected hose bibb outlets



**BL-5550-23**  
Rigid to Swivel Adapter

- Converts 3/8" NPT rigid outlet to swivel
- Accepts T&S goosenecks and swing nozzles
- Use two washers (part no. 000986-45) to make nozzle or gooseneck rigid
- 1-5/16" (33 mm) height



**BL-5550-09**  
Vacuum Breaker

- Anti-siphon vacuum breaker prevents back siphonage
- 3/8" NPT male inlet and female outlet
- Used on outlets of goosenecks
- Use BL-5550-04 on tip on outlet



**BL-5550-12**  
Vandal Resistant Aerator

- 3/8" NPSM male inlet
- Use special wrench to attach (included)
- 3/4" total length
- Fits lab goosenecks and nozzles



**BL-5550-24**  
Swivel to Rigid Adapter

- Converts swivel outlet to 3/8" NPT female for rigid connection
- Accepts T&S rigid goosenecks and nozzles
- 1" (25 mm) height



**BL-5550-30**  
Restricted Swing Adapter

- Fits faucets with 3/8" NPT female outlet
- Restricts the swivel action for 100°
- Requires special nozzle or gooseneck fitted with restrictor pins



Notes

## Lab Accessories

### BL-5560-01 Rigid Gooseneck with Vacuum Breaker

- 3/8" NPT male inlet
- Serrated hose tip
- 8-7/8" (225 mm) total height
- 5-7/16" (138 mm) spread



**BL-5560-02** Same as BL-5560-01 except with swivel connection at vacuum breaker

### BL-5707-05 Spanner Screwdriver

- 8-7/16" (214 mm) spanner screwdriver

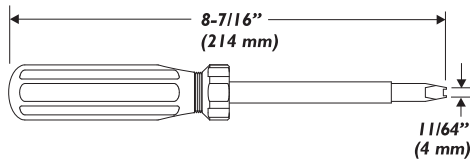

### BL-5561-02 Lab Nozzle

- 9" (229 mm) lab nozzle
- Stream regulator outlet
- Fits swivel faucets



**BL-5561-03** same as BL-5561-02 except 12" (305 mm) long

### BL-5707-10 Vandal Resistant Brace

- 6" (152 mm) vandal resistant brace
- For use on lab equipment



## Loose Key Stops

### B-0415 Straight Loose Key Stop

- 3/8" NPT female inlet and outlet



**B-0416** Same as B-0415 except with 1/2" NPT female inlet and outlet

### B-0418 Angle Loose Key Stop

- 1/2" NPT female inlet and outlet



### B-1311 Angle Key Stop

- 3/8" NPT female inlet
- Outlet with compression nut and sleeve to fit 1/2" (13 mm) O.D. copper tubing



### B-1305 Angle Loose Key Stop

- Flexible supply assembly with loose key angle stop
- 1/2" NPT female inlet
- 1/2" O.D. x 12" (305 mm) long flexible copper tube
- 2-1/2" (64 mm) diameter wall flange

**B-1305-01** Same as B-1305 except with 3/8" O.D. flexible copper tube

**B-1306** Same as B-1305 except with 3/8" NPT female inlet

**B-1306-01** Same as B-1306 except with 3/8" O.D. flexible copper tube



### B-1336 Angle Key Stop

- 3/8" NPT female inlet
- 3/8" NPT female outlet
- Loose key handle
- Vandal resistant (loose key stop)





**Loose Key Stops**

**B-1340  
Angle Stop**

- Angle stop with four arm handle (174F)
- 1/2" NPT female inlet
- Eterna spindle assembly (084A)
- Outlet with compression nut and sleeve to fit 1/2" (13 mm) O.D. copper tubing



**B-1341** Same as B-1340 except with 3/8" NPT female inlet

**B-1344  
Angle Stop**

- Angle stop with four arm handle (174F)
- Eterna spindle assembly (084A)
- 1/2" NPT female outlet



**B-1345** Same as B-1344 except with 3/8" NPT female inlet

**B-1350  
Angle Loose Key Stop**

- 1/2" NPT female inlet
- 1/2" NPT male outlet
- 2" (51 mm) diameter flange



**B-1351** Same as B-1350 except with 3/8" NPT female union coupled outlet

**B-1342  
Angle Key Stop**

- 1/2" NPT female inlet
- Eterna spindle assembly (123A)
- Outlet with compression nut and sleeve to fit 1/2" (13 mm) O.D. copper tubing

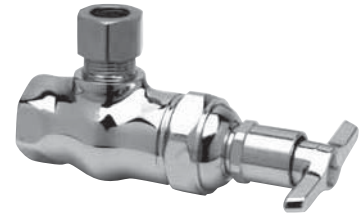

**B-1343** Same as B-0417 except with 3/8" NPT female inlet

**B-1346  
Angle Key Stop**

- 1/2" NPT female inlet
- Eterna spindle assembly (124A)
- 3/8" NPT female outlet
- Loose key handle



**B-1355  
Angle Loose Key Stop**

- 3/8" NPT female union coupling inlet
- 3/8" NPT Female outlet
- 2" (51 mm) diameter wall flange



**D  
65**

**Parts Kits For Plumbing**

**B-0230-K  
Parts Kit**

- Parts included:  
1/2" NPT Supply nipple, lock nut and washer  
1/2" NPT Male and female short EL

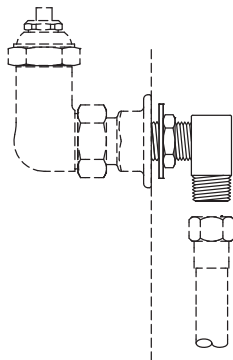

**B-1100-K  
Parts Kit**

- Parts included:  
1/2" NPT Male and female short EL

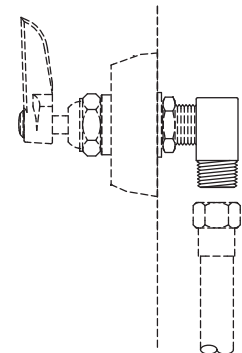

Parts Kits For Plumbing

**B-6K**  
Eterna Spindle Parts Kit

- Parts included:
- 1 000788-20 Right hand Eterna insert
- 1 000789-20 Left hand Eterna insert
- 1 000811-25 Right hand spindle insert
- 1 000812-25 Left hand spindle insert
- 4 000933-45 Seat washer screws
- 10 001022-45 Gaskets
- 12 002601-45 Gaskets
- 22 001092-45 Seat washers



**B-9K**  
Lever Handle Kit

- Parts included:
- 2 001638-45 Lever handle – blank
- 1 001661-45 Index button, red – hot
- 1 001660-45 Index button, blue – cold
- 2 000922-45 Lever handle screw



**B-11K**  
Eterna Cartridge Spindle Kit

- Parts included:
- 1 000811-25 Right hand spindle insert
- 1 000812-25 Left hand spindle insert
- 2 000933-45 Seat washer screw
- 2 009841-45 Seat washer



**B-15K**  
EasyInstall Concealed Widespread Faucet Parts Kit

- Parts included:
- 12 000922-45 Lever handle screw
- 32 000933-45 Screw
- 50 001098-45 Eterna spindle packing seal
- 6 009002-25 Packing nut/lock nut
- 25 002601-45 Gasket
- 25 001074-45 'O'-Ring
- 32 001136-45 Teflon seat washer
- 25 001022-45 Bottom gasket
- 6 000789-20 Left hand removable insert assembly
- 6 000812-25CWS Left hand spindle assembly
- 12 000788-20 Right hand removable insert assembly
- 12 000811-25CWS Right hand spindle assembly

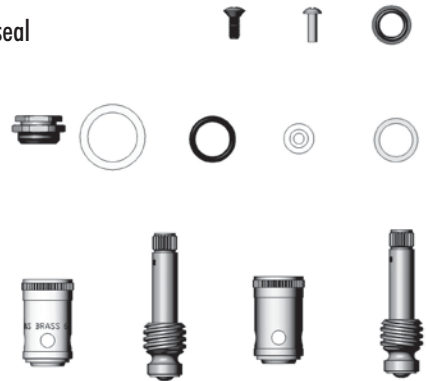

**B-13K**  
Spring Check Spindle Kit

- Parts included:
- 1 001907-25 Right hand spindle insert
- 1 001908-25 Left hand spindle insert
- 2 003164-45 Seat washer – spring check
- 2 001479-45 Spring check spring



**B-2730-DRK**  
Diverter Kit for B-2730

- Parts included:
- 1 Diverter valve stem
- 1 Diverter valve seal
- 2 Diverter valve 'O'-Rings
- 1 Diverter valve body
- 1 Diverter valve stem seal



**Parts Kits For Plumbing**

**B-18K  
Four Arm Handle Kit-Lab**

- Parts included:
- 2 000059-40 Four arm handle
- 2 000925-45 Handle screw
- 1 001191-45 Index button, green – cold
- 1 001194-45 Index button, red – hot



**B-WH4 and B-WH6  
Wrist Action Handles**

- Order:
- B-WH4-H 4" (102 mm) handle, hot index (red) and screw
- B-WH4-C 4" (102 mm) handle, cold index (blue) and screw
- B-WH6-H 6" (152 mm) handle, hot index (red) and screw
- B-WH6-C 6" (152 mm) handle, cold index (blue) and screw
- B-WH4 4" Handle only
- B-WH6 6" Handle only



**B-19K  
Four Arm Handle Kit-Service Sinks**

- Parts included:
- 2 002521-45 Four arm handle
- 2 000922-45 Handle screw
- 1 001660-45 Index button, blue – cold
- 1 001661-45 Index button, red – hot



**B-0466  
Wall Mount Faucet Adapter  
For T&S Faucet To Chicago/  
Zurn Inlets**

- Parts included:
- (2) Faucet adapters, includes (1) santoprene seal and (1) nitrile or EPDM seal per assembly
- 1-3/8" (35 mm) swivel hex nut with internal threads to fit T&S body
- Threads fit Chicago and Zurn inlet flanges



**B-0467  
Wall Mount Faucet Adapter  
For T&S Faucet To Fisher Inlets**

- Parts included:
- (2) Faucet adapters, includes (2) santoprene seals per assembly (one each end)
- 1-3/8" (35 mm) swivel hex nut with internal threads to fit T&S body
- Threads fit Fisher inlet flanges



**B-50P  
Foot Pedal Valve Parts Kit**

- Parts included:
- 4 009306-20 Valve stem
- 4 003690-45 Spring
- 4 000974-45 Bonnet washer
- 4 001040-45 Bonnet washer
- 4 001100-45 Packing stem
- 4 012915-45 B-0107 Seat washer (new style)
- 1 012665-45 Silicon grease tube



## Nozzles, Goosenecks and Spouts

### Swing Nozzles

- Nozzle tip has male threads with a stream regulator

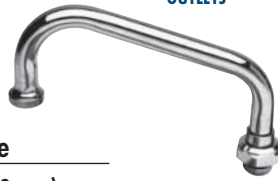

Model No.	Standard Sizes	
	Length	Clearance
059X	6" (152 mm)	2-5/16" (59 mm)
060X	8" (203 mm)	2-15/16" (74 mm)
061X	10" (254 mm)	3-5/8" (92 mm)
062X	12" (305 mm)	3-3/4" (95 mm)
063X	14" (356 mm)	5" (127 mm)
064X	16" (406 mm)	5-13/16" (147 mm)
065X	18" (457 mm)	6-3/8" (162 mm)

059XM	Master Box (12)	064XM	Master Box (12)
060XM	Master Box (12)	065XM	Master Box (12)
061XM	Master Box (12)	060XP	Plain end outlet
062XM	Master Box (12)	062XP	Plain end outlet
063XM	Master Box (12)		

Note: Use Series 1 outlets on these swing nozzles

### Swivel Gooseneck

- Nozzle tip has male threads with a stream regulator



Model No.	Standard Sizes		
	Spread	Height	Clearance
131X	2-13/16" (71 mm)	4-3/4" (120 mm)	2-9/16" (65 mm)
132X	2-3/4" (70 mm)	9-1/16" (230 mm)	5-9/16" (142 mm)
133X	5-11/16" (145 mm)	10-3/8" (264 mm)	6-3/8" (162 mm)
134X	7-3/4" (192 mm)	11-7/16" (290 mm)	5-1/2" (139 mm)
135X	8-3/4" (223 mm)	12-1/16" (306 mm)	5-9/16" (141 mm)
136X	12-1/4" (310 mm)	14-11/16" (373 mm)	5-3/8" (137 mm)

#### Swivel Gooseneck/Stream Regulator:

131X-ADA	ADA gooseneck
131XM	Master Box (6)
132XM	Master Box (6)
133XM	Master Box (6)
135XM	Master Box (6)

#### Swivel Gooseneck/Plain End:

132XP	Same as 132X except with plain end
133XP	Same as 133X except with plain end
134XP	Same as 134X except with plain end

Note: Use Series 2 outlets on these goosenecks except for 131X and 133X, which use Series 1 outlets

### Double-Joint Nozzles

- Nozzle tip has male threads with a stream regulator



Model No.	Standard Sizes		
	Back	Front	Total
066X	6" (152 mm)	6" (152 mm)	12" (305 mm)
067X	9" (229 mm)	6" (152 mm)	15" (381 mm)
068X	12" (505 mm)	6" (152 mm)	18" (457 mm)
069X	12" (305 mm)	12" (305 mm)	24" (610 mm)

#### Double-Joint Nozzle Sections

151X	6" (152 mm) back section
152X	9" (229 mm) back section
153X	6" (152 mm) front section

Note: Use Series 1 outlets on these nozzles

### Rigid Gooseneck

- Nozzle tip has 3/8" NPSM outlet with a stream regulator



Model No.	Standard Sizes		
	Spread	Height	Clearance
119X	2-3/4" (70 mm)	8-3/4" (222 mm)	5-1/4" (133 mm)
120X	5-1/2" (140 mm)	10-1/4" (261 mm)	5-5/16" (135 mm)
122X	5-1/2" (140 mm)	11-1/2" (292 mm)	6-7/16" (164 mm)
123X	5-1/2" (140 mm)	12-1/2" (318 mm)	7-1/2" (190 mm)
124X	5-1/2" (140 mm)	13-1/2" (343 mm)	8-9/16" (217 mm)
125X	5-1/2" (140 mm)	14-1/2" (368 mm)	9-9/16" (243 mm)
126X	5-1/2" (140 mm)	15-1/2" (394 mm)	10-1/2" (267 mm)
127X	7-5/8" (194 mm)	10-1/2" (267 mm)	4-1/2" (114 mm)
128X	7-5/8" (194 mm)	13-1/2" (343 mm)	7-9/16" (192 mm)
129X	8-5/8" (219 mm)	11-3/4" (298 mm)	5-1/2" (140 mm)
130X	12-3/16" (310 mm)	13-3/8" (340 mm)	4-9/16" (116 mm)
165X	4-1/16" (103 mm)	8-1/4" (210 mm)	4-13/16" (122 mm)

#### Rigid Gooseneck/Stream Regulator:

120XM	Master Box (6)
-------	----------------

#### Rigid Gooseneck/Plain End:

120XP	Same as 120X except with plain end
122XP	Same as 122X except with plain end
129XP	Same as 129X except with plain end

Note: Use Series 2 outlets on these goosenecks

Nozzles, Goosenecks and Spouts

Soap Dish Nozzle

- Nozzle has 3/8" NPSM female outlet with stream regulator
- A swing nozzle with soap dish can be supplied on T&S faucets instead of the standard nozzle



Model No.	Length
160X	6" (152 mm)
161X	8" (203 mm)
162X	12" (305 mm)
163X	18" (457 mm)

Note: Use Series 2 outlets on these nozzles

Rigid Vacuum Breaker Gooseneck

- Rigid polished chrome plated gooseneck with vacuum breaker
- 3/8" NPT male inlet
- Nozzle has 3/8" NPSM female outlet with stream regulator



Model No.	Spread	Height	Clearance
B-0405-02	5-5/8" (142 mm)	8-7/8" (226 mm)	4-1/2" (114 mm)
B-0405-03	8-9/16" (218 mm)	8-7/8" (226 mm)	4-1/2" (114 mm)
B-0405-04	11-5/8" (295 mm)	8-7/8" (226 mm)	4-1/2" (114 mm)

Note: Use Series 2 outlets on these goosenecks

Vacuum Breaker Swing Nozzle with Stream Regulator

- Nozzle has 3/8" NPSM female outlet with stream regulator
- Vacuum breaker swing nozzles can be supplied on T&S faucets instead of nozzles ordinarily furnished to meet local code requirements



Model No.	Spread	Height
B-0408-02	5-5/8" (143 mm)	3-11/16" (94 mm)
B-0408-03	8-5/8" (219 mm)	3-11/16" (94 mm)
B-0408-04	11-5/8" (295 mm)	3-11/16" (94 mm)

Note: Use Series 2 outlets on these nozzles

OCS6 Swivel Cast Spout

SERIES 2 OUTLETS

- Polished chromium plated cast nozzle with aerator outlet



Model No.	Length	Height	Clearance
OCS6	6" (152 mm)	2-3/8" (60 mm)	15/16" (24 mm)
OCS8	8" (203 mm)	5-3/16" (132 mm)	3-13/16" (96 mm)

OCS6-LT 6" (152 mm) with B-LT stream regulator  
 OCS8-LT 8" (229 mm) with B-LT stream regulator

Note: Use Series 2 outlets on these spouts

Swivel Vacuum Breaker Gooseneck

- 3/8" NPT male inlet
- Nozzle has 3/8" NPSM female outlet with stream regulator
- B-0406-02, -03, -04 Rigid polished chrome plated gooseneck with swivel vacuum breaker – swivels at vacuum breaker
- B-0407-02, -03, -04 Swivel polished chrome plated gooseneck with vacuum breaker – swivels at base



Model No.	Spread	Height	Clearance
B-0406-02	5-5/8" (143 mm)	9" (229 mm)	4-11/16" (119 mm)
B-0406-03	8-5/8" (219 mm)	9" (229 mm)	4-11/16" (119 mm)
B-0406-04	11-5/8" (295 mm)	9" (229 mm)	4-11/16" (119 mm)
B-0407-02	5-5/8" (143 mm)	8-11/16" (221 mm)	4-3/8" (111 mm)
B-0407-03	8-5/8" (219 mm)	8-11/16" (221 mm)	4-3/8" (111 mm)
B-0407-04	11-5/8" (295 mm)	8-11/16" (221 mm)	4-3/8" (111 mm)

Note: Use Series 2 outlets on these goosenecks

Vacuum Breaker Swing Nozzle with Garden Hose Thread

- Nozzle has 3/4" garden hose thread outlet
- Vacuum breaker swing nozzles can be supplied on T&S faucets instead of nozzles ordinarily furnished to meet local code requirements



Model No.	Spread	Height
B-0409-02	5-5/8" (143 mm)	3-11/16" (94 mm)
B-0409-03	8-5/8" (219 mm)	3-11/16" (94 mm)
B-0409-04	11-5/8" (295 mm)	3-11/16" (94 mm)

Note: Use Series 2 outlets on these nozzles

## Big-Flo Nozzles

**NEW MODELS!**

### Big-Flo Double Joint Nozzle

- Double-joint nozzle for Big-Flo faucets with 3/4" inlets

**116X** 24" (610 mm) double joint swing nozzle  
**117X** 12" (305 mm) front section of double joint swing nozzle

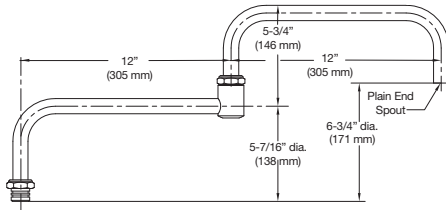

### Big-Flo Swing Nozzles

- For use with Big-Flo faucets with 3/4" inlets



Model No.	Standard Length	Standard Clearance	Standard Height
<b>114X</b>	12" (305 mm)	5-3/16" (132 mm)	8-5/8" (219 mm)
<b>115X</b>	18" (457 mm)	7-3/16" (183 mm)	10-5/8" (270 mm)

Note: No special outlets are available for these spouts

## Special Custom Goosenecks and Nozzles

### 002848-40 Range Faucet Nozzle

- 18" (457 mm) length, 12" (305 mm) front, 6" (152 mm) back



### B-2387 Swivel Gooseneck

- For use with swivel type base faucets
- Chrome plated
- 8-1/2" (216 mm) spread swivel gooseneck
- 10-1/8" (257 mm) total height
- Non-splash aerator (B-0199-01)
- Other dimensions available upon request



## Conversion Adapters

### B-0412 Adapter

- Rigid to swivel adapter
- Use for field conversion where a faucet with 3/8" NPT outlet is installed and a swivel gooseneck or nozzle is required
- Use two (2) 7X washers (000986-45) to make gooseneck or nozzle rigid



**B-0412-M** Master Box (2)

### B-0413 Adapter

- Swivel to rigid adapter
- Used for field conversion where a faucet with swivel outlet is installed and a rigid pipe gooseneck is required



**B-0413-M** Master Box (2)  
**B-0413-M50** Master Box (50)

### B-0414 Adapter

- Gooseneck coupling
- Adapts a 3/8" IPS pipe gooseneck to faucets with 3/8" IPS outlet providing either a swivel or union connection



**B-0414-M** Master Box (2)

### EZ-SWIVEL-CZ Swivel Adapter

- Swivel adapter for Chicago and Zurn faucets

### EZ-SWIVEL-FM Swivel Adapter

- Swivel adapter for Fisher faucets

D  
70

## Quick-Connect Coupling Set

### B-0452 Quick-Connect Coupling Set

- Chrome plated brass
- For use with water, air and non-corrosive gases
- When 1/4 NPT plug is removed from quick-connect socket, flow is automatically shut off

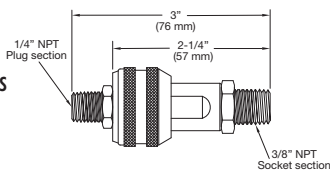

### B-0412-FXX Low Flow Adapter

New Water-Saving Adapter

- Rigid to swivel adapter with flow control tower
- Refer to "Flow Tower Chart" to specify flow desired and add numbers to model suffix
- 1"-20 UN male thread x 3/8"-18 NPT male thread
- For use on lavatory faucets to conserve water

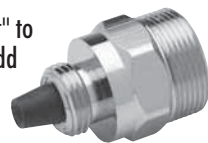

Model No.	Flow (GPM)
<b>B-0412-F03</b>	0.25
<b>B-0412-F05</b>	0.40
<b>B-0412-F07</b>	0.70
<b>B-0412-F10</b>	0.90
<b>B-0412-F12</b>	1.20
<b>B-0412-F15</b>	1.40
<b>B-0412-F16</b>	1.60
<b>B-0412-F20</b>	2.00

**Handles**

**001144-45  
Alpine Handle**

- Clear lexan handle
- Fits most T&S faucets
- Order chrome plated index buttons separately

**001327-40** Cold Index  
**001328-40** Hot Index  
**001326-40** Blank Index



**001784-40  
Dome Handle**

- Polished chrome zinc metal handle
- Conceals stem and bonnet
- Screw and index blue (cold) sold separately



**001783-40** Dome handle, with red (hot) index sold separately

**B-WH4  
Wrist Action Handle**

- Chrome plated forged brass handle, 4" (102 mm) long
- Fits all T&S faucets
- Cold index: 001686-45
- Hot index: 001194-45
- Screw only: 000925-45
- Available with antimicrobial coating



**B-WH4H** Includes 4" handle, hot index button and screw  
**B-WH4C** Includes 4" handle, cold index button and screw  
**B-WH6** Same as B-WH4 except 6" (152 mm) long  
**B-WH6H** Includes 6" handle, hot index button and screw  
**B-WH6C** Includes 6" handle, cold index button and screw

**Push Button Handle**

- Chrome plated handle for metering faucets
- Available with antimicrobial coating



**014194-40** Hot, with vandal resistant screw and spanner bit  
**014195-40** Cold, with vandal resistant screw and spanner bit  
**014193-40** Blank, with vandal resistant screw and spanner bit

**Soap Dishes**

**B-SD  
Soap Dish**

- Chrome plated
- Must be used with soap dish nozzle or B-SDA soap dish assembly



**001636-45  
Lever Handle**

- Chrome plated zinc handle
- Blue index button and screw (cold)
- Available with antimicrobial coating



**001637-45** Lever handle with red index (hot) and screw  
**001638-45** Lever handle with no index  
**010027-40** Chrome plated solid brass handle

**002521-45  
Four Arm Handle**

- Chrome plated zinc handle
- Order handle screw separately (000922-45)
- Available with antimicrobial coating
- Order index for hot or cold separately:



**001660-45** Cold handle index (blue)  
**001661-45** Hot handle index (red)

**Club Handle**

- Chrome plated decorative handle

**009332-41** Hot side  
**009331-41** Cold side



**Pivot Action Metering Handle**

- Chrome plated handle for pivot action metering faucets
- Available with antimicrobial coating



**PA-H** Hot, with retaining nut and spanner bit  
**PA-C** Cold, with retaining nut and spanner bit  
**PA-B** Blank, with retaining nut and spanner bit

**B-SDA  
Soap Dish Assembly**

- Chrome plated
- Clamps onto 3/8" NPT goosenecks or risers



## Aerators

**NEW**  
Water-Saving  
Models!

**NEW!**

Check out our new water-saving aerators and outlets!

Series 1	Series 2	Series 3	Series 4	Series 5
<ul style="list-style-type: none"> <li>• 55/64"-27 UN female aerator threads</li> <li>• Fits all swing nozzles and 131X, 133X gooseneck</li> <li>• -WS models are water-saving aerators</li> </ul>	<ul style="list-style-type: none"> <li>• 3/8" NPSM male thread</li> <li>• Fits goosenecks</li> <li>• -WS models are water-saving aerators</li> </ul>	<ul style="list-style-type: none"> <li>• 13/16"-27 UN male aerator thread</li> <li>• Fits lavatory spouts</li> <li>• -WS models are water-saving aerators</li> </ul>	<ul style="list-style-type: none"> <li>• 15/16"-27 UN male thread</li> <li>• Fits single lever line</li> <li>• -WS models are water-saving aerators</li> </ul>	<ul style="list-style-type: none"> <li>• 13/16"-24 UN female thread</li> <li>• Fits other manufacturer's faucets</li> <li>• Includes adapter and washer with aerator</li> </ul>

### Standard Aerators

Aerator		Series 1	Series 2	Series 3	Series 4	Series 5
<ul style="list-style-type: none"> <li>• Non-splash aerator</li> </ul> 		<b>B-0199-01</b> (2.2 GPM)	<b>B-0199-02</b> (2.2 GPM)	<b>B-0199-03</b> (2.2 GPM)	<b>B-0199-04</b> (2.2 GPM)	

Vandal Resistant Aerator		Series 1	Series 2	Series 3	Series 4	Series 5
<ul style="list-style-type: none"> <li>• Vandal resistant, non-splash aerator</li> <li>• Use tool to attach and remove aerator</li> </ul> 		<b>B-0199-06</b> (2.2 GPM)	<b>B-0199-07</b> (2.2 GPM)	<b>B-0199-08</b> (2.2 GPM)	<b>B-0199-09</b> (2.2 GPM)	

### Water-Conserving Aerators

Aerator with Flow Control		Series 1	Series 2	Series 3	Series 4	Series 5
<ul style="list-style-type: none"> <li>• Non-splash aerator with flow control</li> </ul> 		<b>B-0199-01F-XX</b>	<b>B-0199-02F-XX</b>	<b>B-0199-03F-XX</b>		
<b>Refer to Aerator Flow Chart to add Suffix Numbers</b>						

Vandal Resistant Aerator with Flow Control		Series 1	Series 2	Series 3	Series 4	Series 5
<ul style="list-style-type: none"> <li>• Non-splash, vandal resistant aerator with flow control</li> <li>• Tool to attach and remove aerator</li> </ul> 		<b>B-0199-06F-XX</b>	<b>B-0199-07F-XX</b>	<b>B-0199-08F-XX</b>		
<b>Refer to Aerator Flow Chart to add Suffix Numbers</b>						

NEW! Non-Splash Aerator 1.5 GPM		Series 1	Series 2	Series 3	Series 4	Series 5
<ul style="list-style-type: none"> <li>• Non-splash aerator with flow control</li> </ul> 		<b>B-0199-01-WS</b> (1.5 GPM)	<b>B-0199-02-WS</b> (1.5 GPM)	<b>B-0199-03-WS</b> (1.5 GPM)	<b>B-0199-04-WS</b> (1.5 GPM)	<b>B-0199-05-WS</b> (1.5 GPM)

NEW! Vandal Resistant Aerator 1.5 GPM		Series 1	Series 2	Series 3	Series 4	Series 5
<ul style="list-style-type: none"> <li>• Non-splash, vandal resistant aerator with flow control</li> <li>• Tool to attach and remove aerator</li> </ul> 		<b>B-0199-06-WS</b> (1.5 GPM)	<b>B-0199-07-WS</b> (1.5 GPM)	<b>B-0199-08-WS</b> (1.5 GPM)	<b>B-0199-09-WS</b> (1.5 GPM)	<b>B-0199-10-WS</b> (1.5 GPM)

**NEW**  
Water-Saving  
Models!

**D**  
**72**

Aerator Flow Chart					
Flow (GPM)	Suffix	Color Code	Flow (GPM)	Suffix	Color Code
0.25	F03	No color	1.20	F12	Orange
0.40	F05	Brown	1.40	F15	Purple
0.70	F07	Green	2.00	F20	Yellow
0.90	F10	Grey			

GPM ± 10%

**To order:**  
Select flow desired, then add suffix to model number.  
For ex., B-0199-02**F15** for 1.40 GPM

**Note:**  
Painted mark on each flow control within the assembly indicates flow of unit.





**Laminar Flow Outlets**



**NEW!**

Check out our new non-splash, non-aerated laminar flow devices!

	<b>Series 1</b>	<b>Series 3</b>	<b>Series 4</b>
<ul style="list-style-type: none"> <li>• 55/64"-27 UN female aerator threads</li> <li>• Fits all swing nozzles, 131X, 133X gooseneck</li> </ul>	<ul style="list-style-type: none"> <li>• 13/16"-27 UN male aerator thread</li> <li>• Fits lavatory spouts</li> </ul>	<ul style="list-style-type: none"> <li>• 15/16"-27 UN male thread</li> <li>• Fits single lever line</li> </ul>	
<p><b>Laminar Flow Regulator</b></p> <ul style="list-style-type: none"> <li>• Non-splash, non-aerated stream</li> <li>• Screenless; for use in medical facilities to prevent airborne bacteria from entering water stream</li> </ul> 	<p><b>B-0199-21</b> (2.2 GPM)</p> <p><b>B-0199-29</b> (1.5 GPM)</p>	<p><b>B-0199-26</b> (2.2 GPM)</p>	<p><b>B-0199-25</b> (2.2 GPM)</p>
<p><b>NEW! Vandal Resistant Laminar Flow</b></p> <ul style="list-style-type: none"> <li>• Same as B-0199-21 except is vandal resistant with key</li> <li>• -VR - female thread</li> <li>• -VRF - female thread</li> <li>• -VRM - male thread</li> </ul> 	<p><b>B-0199-29-VR</b> (1.5 GPM)</p> <p><b>B-0199-21-VRF</b> (2.2 GPM)</p> <p><b>B-0199-21-VRM</b> (2.2 GPM)</p>	<p><b>B-0199-28</b> (2.2 GPM)</p>	<p><b>B-0199-27</b> (2.2 GPM)</p>

**NEW! Non-Aerated Spray Devices**





NEW! Water-saving 0.35 GPM and 0.5 GPM flow rate



**NEW!**

Check out our new water-saving non-aerated spray devices with 0.35 and 0.5 GPM!

	<b>Series 1</b>	<b>Series 2</b>	<b>Series 3</b>	<b>Series 4</b>	<b>Series 5</b>
<ul style="list-style-type: none"> <li>• 55/64"-27 UN female thread</li> <li>• Fits all swing nozzles, 131X, 133X gooseneck</li> </ul>	<ul style="list-style-type: none"> <li>• 3/8" NPSM male thread</li> <li>• Fits goosenecks</li> </ul>	<ul style="list-style-type: none"> <li>• 13/16"-27 UN male thread</li> <li>• Fits lavatory spouts</li> </ul>	<ul style="list-style-type: none"> <li>• 15/16"-27 UN male thread</li> <li>• Fits single lever line</li> </ul>	<ul style="list-style-type: none"> <li>• 13/16"-24 UN female thread</li> <li>• Fits other manufacturer's faucets</li> </ul>	
<p><b>Non-Aerated Spray Device</b></p> <ul style="list-style-type: none"> <li>• Non-splash non-aerated spray device</li> </ul> 	<p><b>B-0199-01-N035</b> (0.35 GPM)</p> <p><b>B-0199-01-N05</b> (0.5 GPM)</p>	<p><b>B-0199-02-N035</b> (0.35 GPM)</p> <p><b>B-0199-02-N05</b> (0.5 GPM)</p>	<p><b>B-0199-03-N035</b> (0.35 GPM)</p> <p><b>B-0199-03-N05</b> (0.5 GPM)</p>	<p><b>B-0199-04-N035</b> (0.35 GPM)</p> <p><b>B-0199-04-N05</b> (0.5 GPM)</p>	<p><b>B-0199-05-N035</b> (0.35 GPM)</p> <p><b>B-0199-05-N05</b> (0.5 GPM)</p>
<p><b>Vandal Resistant Non-Aerated Spray Device</b></p> <ul style="list-style-type: none"> <li>• Non-splash, vandal resistant non-aerated spray device</li> <li>• Tool to attach and remove outlet</li> </ul> 	<p><b>B-0199-06-N035</b> (0.35 GPM)</p> <p><b>B-0199-06-N05</b> (0.5 GPM)</p>	<p><b>B-0199-07-N035</b> (0.35 GPM)</p> <p><b>B-0199-07-N05</b> (0.5 GPM)</p>	<p><b>B-0199-08-N035</b> (0.35 GPM)</p> <p><b>B-0199-08-N05</b> (0.5 GPM)</p>	<p><b>B-0199-09-N035</b> (0.35 GPM)</p> <p><b>B-0199-09-N05</b> (0.5 GPM)</p>	<p><b>B-0199-10-N035</b> (0.35 GPM)</p> <p><b>B-0199-10-N05</b> (0.5 GPM)</p>

## Outlets

### Series 1 Outlets

**NEW**  
Water-Saving  
Models!

- 55/64"-27 UN female aerator threads
- Fits all swing nozzles and 131X, 133X goosenecks

#### B-0103-01 Rosespray

- Female aerator thread
- Solid brass construction



#### B-GFE Garden Hose Outlet

- Female aerator thread
- Fits on end of nozzle or gooseneck to convert aerator male thread to male garden hose thread



#### B-PT Stream Regulator

- Female aerator thread
- Plain outlet with screen and washer



#### B-0199-22 Swivel Aerator

- 55/64"-27 UN female inlet
- Includes 15/16"-27 UN male adapter
- Swivel outlet
- 2.2 GPM
- Dual spray pattern: aerator or rosespray



#### B-0199-VR-KEY Pro Key

**NEW**  
Vandal-Resis-  
tant Key!

- Pro key for vandal-resistant aerators



### Series 2 Outlets

**NEW**  
Water-Saving  
Models!

- 3/8" NPSM male thread
- Fits goosenecks

#### B-0103 Rosespray

- Solid brass construction
- 4 GPM
- 3/8" NPSM male thread

**NEW** water-saving models available:

**B-0103-Fxx** models with flow control assembly and 3/8"-18 NPT male thread — refer to Flow Tower Chart at right to specify flow desired and add numbers to model suffix



#### Flow Tower Chart

Model No.	Flow (GPM)
B-0103-F03	0.25
B-0103-F05	0.40
B-0103-F07	0.70
B-0103-F10	0.90
B-0103-F12	1.20
B-0103-F15	1.40
B-0103-F20	2.00

#### B-0198-FXX Series Serrated Hose End

- 3/8" NPT male inlet thread
- Serrated hose end accepts rubber or plastic tubing up to 1/2" I.D.
- Refer to Flow Tower Chart below to specify flow desired and add numbers to model suffix



#### Flow Tower Chart

Model No.	Flow (GPM)
B-0198-F03	0.25
B-0198-F05	0.40
B-0198-F07	0.70
B-0198-F10	0.90
B-0198-F12	1.20
B-0198-F15	1.40
B-0198-F20	2.00

**For Serrated Hose End**

**To order:**  
Select flow desired, then add suffix to model number.

Ex.: B-0198-**F03** for 0.25 GPM

#### B-GH Garden Hose Outlet

- 3/8" NPSM male x garden hose male adapter



#### B-LT Stream Regulator

- 3/8" male thread
- Plain outlet



## Adapters, Inlets, Supply Connectors and Parts Kits

### Adapter Chart

Dimensions				Model
3/8 NPSM	male	x 3/4-11 1/2 G.H.	male	<b>B-GH</b>
1/2 NPT	male	x 3/8 NPT	female (Face bushing)	<b>002337-45</b>
1/2 NPT	male	x 3/8 NPT	female (Hex bushing)	<b>001359-40</b>
3/4-14	male	x 1/4 NPT	male (Fisher adapter)	<b>002584-25 (172A)</b>
3/4-14	male	x 1/4 NPT	female	<b>000544-25 (52A)</b>
3/4-14	male	x 3/8 NPT	male (Chicago adapter)	<b>000545-25 (53A)</b>
3/4-14	male	x 3/8 NPE	female (Hex stock)	<b>000546-25 (54A)</b>
3/4 G.H.	female	x 1/2 NPT	male	<b>003105-40</b>
3/4-14	male	x 5/8-27	female	<b>000552-25</b>
3/4-14	male	x 3/4 NPT	male	<b>000549-25 (57A)</b>
3/4-14	male	x 3/4 NPT	female	<b>000550-25 (58A)</b>
3/4-14	male	x 3/4-14	male	<b>001806-25 (98A)</b>
55/64-27	male	x 1/8 NPT	female	<b>001624-25</b>
55/64-27	male	x 5/8-27	female	<b>000554-25</b>
55/64-27	female	x 3/4-11 1/2 G.H.	male	<b>B-GFE</b>

### 150A Union Coupling Tailpiece

- 1/4" NPT tailpiece with nut fits 1/2" NPT and NPS faucet shanks with 30" tapered inlet

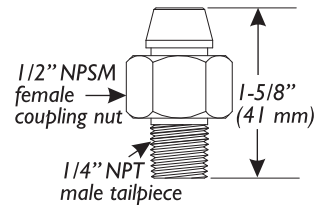

### 006895-20 Short Elbow

- 1/2" female connectors
- Used with 1/2" male threaded supplies to provide 90° turns at inlets



## Inlets and Supply Connections

### B-0425 Supply Nipple

**B-0425-M** Master Box (2)

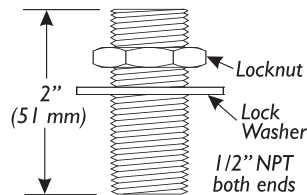

### B-0426 Supply Nipple

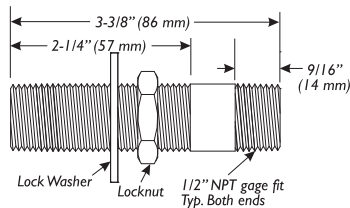

### B-0427 Supply Nipple

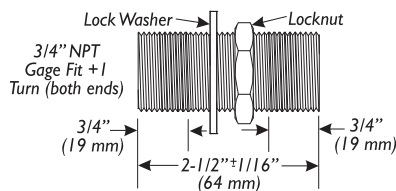

### B-0428 Supply Nipple

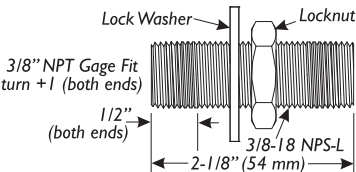

### B-0429 Supply Nipple

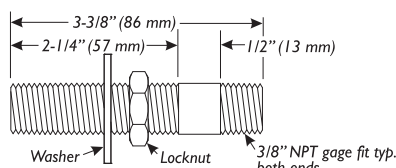

### B-0230-K Parts Kit

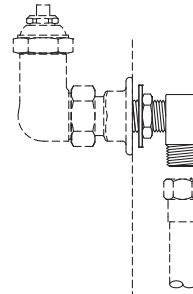

- Parts included:  
1/2" NPT Supply nipple, lock nut and washer  
1/2" NPT Male x Female short EL

### B-1100-K Parts Kit

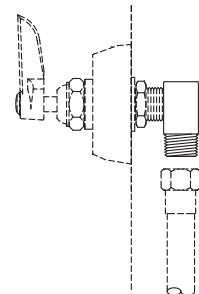

- Parts included:  
1/2" NPT Male x Female short EL

### B-0230-KIT Parts Kit

- Parts included:  
2 1/2" inlet shanks and close elbows –inlet assembly kit (2 sets per kit)  
1 24" flexible supply hose (two sets per kit)

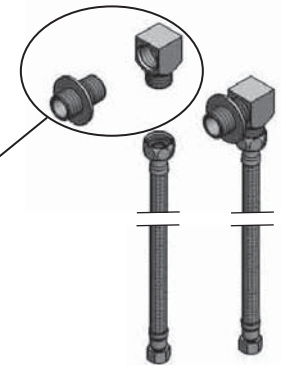

Supply Nipple	Length
3/8" B-0428	2-1/8" (54 mm)
B-0429	3-3/8" (86 mm)
1/2" B-0425	2" (51 mm)
B-0426	3-3/8" (86 mm)
3/4" B-0427	2-1/2" (64 mm)

These red brass supply nipples have tapered pipe threads on each end and a running thread between. They are used on faucets with female inlets to make up tightly to vertical or horizontal surfaces. Washer and nut included. Available in chrome if specified.

## Risers and Connectors

### 3/8" Riser Lengths

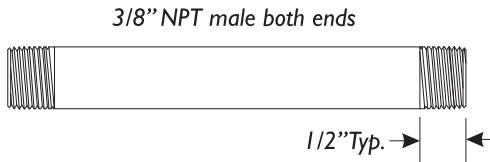

Model No.	Length	Model No.	Length
000357-40	2" (51 mm)	000369-40	18" (457 mm)
000358-40	3" (76 mm)	000372-40	24" (610 mm)
000361-40	5" (127 mm)	000376-40	32" (813 mm)
000363-40	7" (178 mm)		

Contact factory for sizes not shown.

### Couplings

- Used to connect two (2) pipes
- Same thread size on both ends

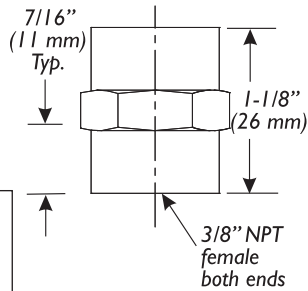

Dimension	Model No.
3/8" NPT female	001769-40
3/4-14 NPT female	001596-25

### Elbows and Tees

#### 148X

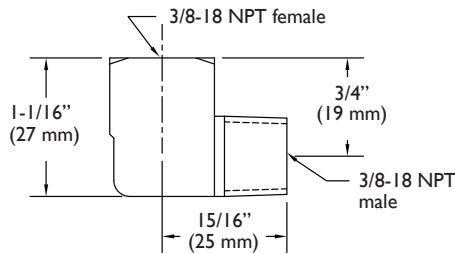

#### 001355-40

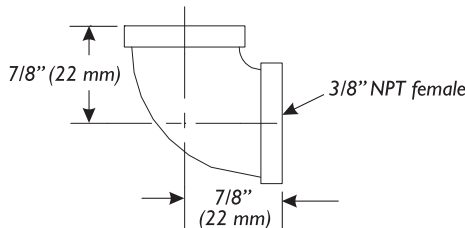

#### 00LL

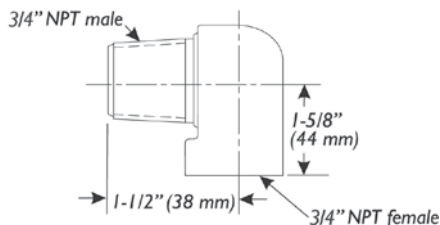

### Close Nipples

- Used to connect two (2) pipes
- Male x male
- Same thread size on both ends
- Close nipple will be completely concealed

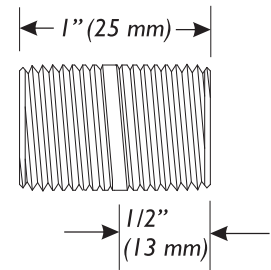

Dimension	Model No.
3/8" NPT male	002535-25
1/2" NPT male	002534-25

### B-CVV1-2 Check Valve

- Rough brass finish
- Chrome plated available upon request
- Designed for water use only



**B-CVH1-2** for horizontal or vertical use, 1/2" NPT female  
**B-CVH3-4** for horizontal or vertical use, 3/4" NPT female  
 Furnished in rough brass

#### 150X

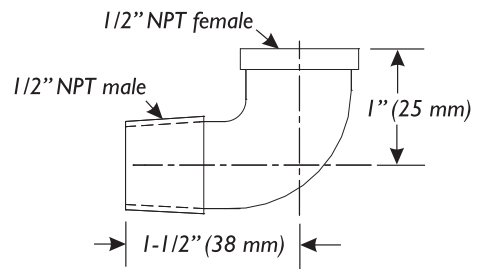

### Elbows

Description	Model No.
3/8" Street elbow	148X
3/8" Elbow	001355-40
1/2" Short elbow	006895-20
1/2" Street elbow	150X
1/2" Elbow	001357-40
3/4" Short elbow	00LL
3/4" Elbow	001720-40

## Inlet Product Options

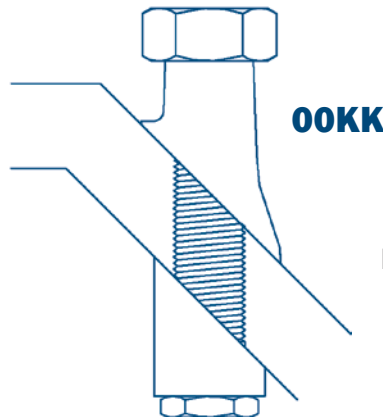
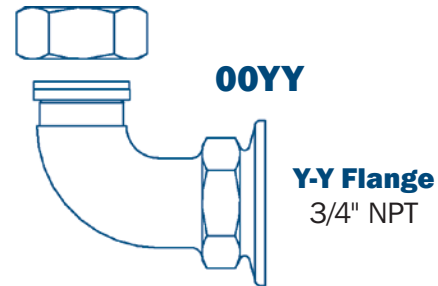
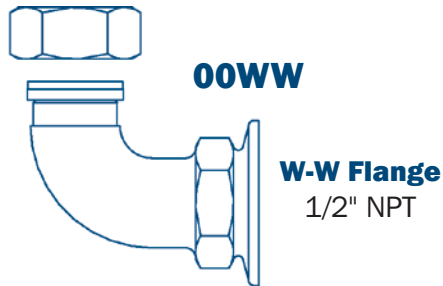
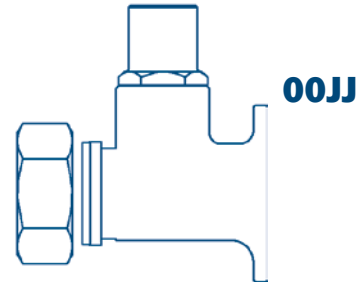
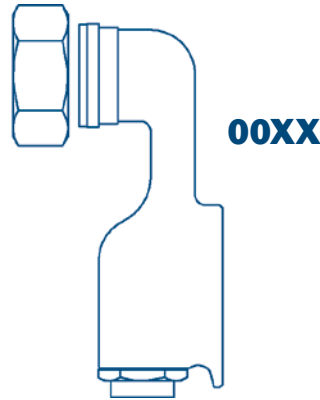
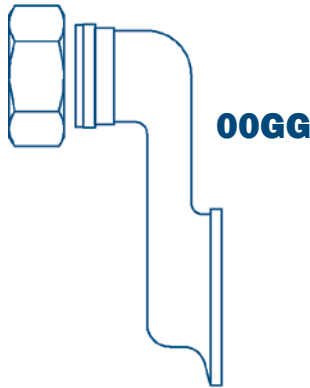
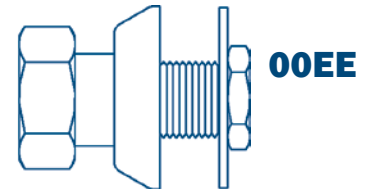
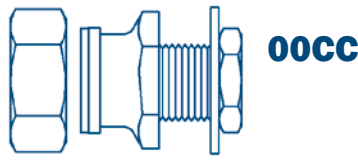
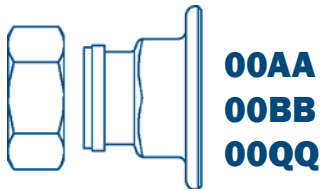

For use with deck at 45° angle  
Max. countertop thickness 1"

### Union Coupling Inlets

The following inlets are polished chrome plated and used on mixing faucets to meet varying conditions of installation. All are interchangeable and are used in lieu of the "00AA" inlets which are ordinarily furnished on faucets using union coupling inlets. All are available in rough chrome if specified. To order, add suffix letters to faucet model number. For example: "B-0230-CC" – Sink mixing faucet with 1/2" NPT male inlet, 1" (25 mm) long.

- 00AA** 1/2" NPT female eccentric flanged inlet
- 00BB** 3/4" NPT female eccentric flanged inlet
- 00CC** 1/2" NPT male inlet, 1" (25 mm) long
- 00EE** 1/2" NPT male inlet with adjustable flange, 1" (25 mm) long
- 00GG** 1/2" NPT female flanged adjustable inlet
- 00XX** 1/2" NPT female flanged adjustable inlet with screwdriver stop
- 00JJ** 1/2" NPT female inlet with loose key stop
- 00WW** 1/2" NPT female flange 90° inlet
- 00YY** 3/4" NPT female flange 90° inlet
- 00KK** 1/2" NPT male inlet for use on 45° decks. Inlet is at 45° angle to mounting face.
- 00QQ** 3/8" NPT female eccentric flanged inlet

**Inlet Extensions**

**B-0440**

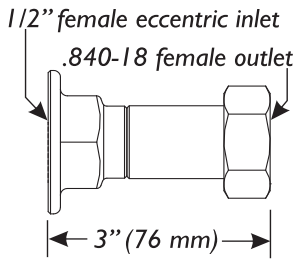

**B-0441**

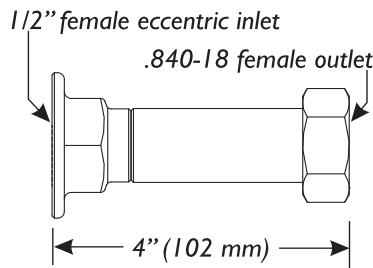

**B-0442**

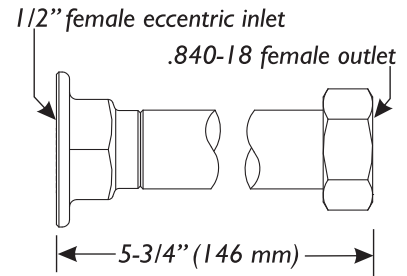

**B-0443**

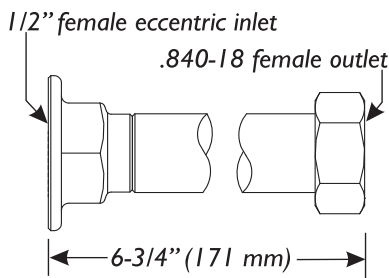

**B-0445**

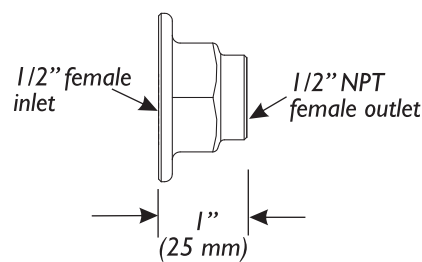

**B-0446**

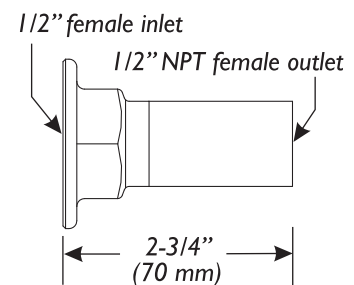

**B-0447**

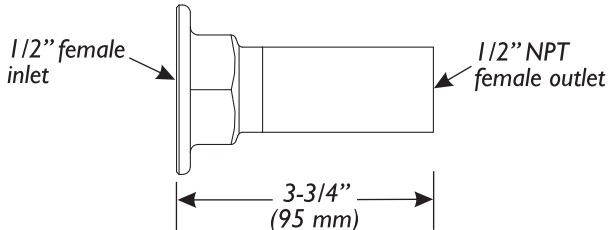

**B-0448**

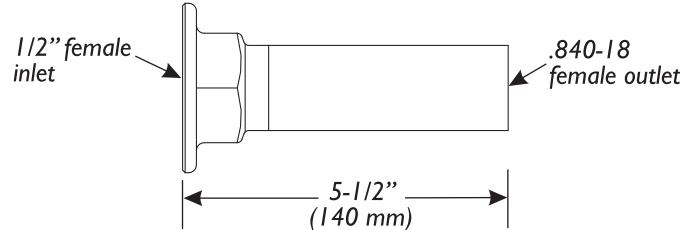

**B-0449**

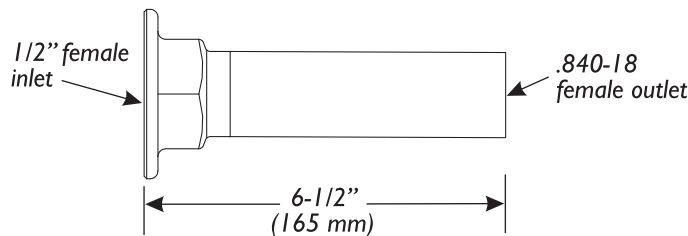

Note: .840-18 female outlet accepts insert (000684-20) which connects inlet extension to faucet body

**Inlet Extensions**

The following inlet extensions are polished chrome plated and used on the inlets of either wall or deck mounted union coupling style mixing faucets to extend inlets. 00AA 1-1/4" (32 mm) inlet standard on typical wall mounted faucets (B-0230, for example).  
**B-0440** Adds 1-3/4" (44 mm) to standard 00AA  
**B-0441** Adds 2-3/4" (70 mm) to standard 00AA  
**B-0442** Adds 4-1/2" (114 mm) to standard 00AA  
**B-0443** Adds 5-1/2" (140 mm) to standard 00AA

The following inlet extensions are used to extend faucets with male 1/2" NPT inlets.

Ex.: B-0704 faucet with B-0447 inlet extension.  
**B-0445** 1" (25 mm)  
**B-0446** 2-3/4" (70 mm)  
**B-0447** 3-3/4" (95 mm)  
**B-0448** 5-1/2" (140 mm)  
**B-0449** 6-1/2" (165 mm)